

Takis Tsiricos

One Flew Over Pac-Man's Nest

*An Authoritative Study on Emulators and the Problems that they
Pose in Relation to Intellectual Property Rights*

Supervised by Alan Bruce Grant, Newcastle Law School Lecturer

University of Newcastle Upon Tyne
Newcastle Upon Tyne
MCMXCIX-MM

An Introduction for the Emulation Community

“One flew over Pac-Man’s Nest” contains information regarding the technical facts of emulation in relation to law, with a particular, but not exclusive, eye to European Law. Although not all of the existing emulators are covered individually, I have chosen to refer to those which serve as a typical example. You do not have to be a lawyer or have legal knowledge in order to follow the meaning of it but, it may be occasionally hard to follow, especially with regards to language, as I have written this text as part of my Law Masters degree. Similarly, some limitations had to apply, for example a word limit. Although one cannot claim that it covers all the potential aspects to their entirety, competition law for example being omitted, it is my view from what reading I have done that my findings would not differ a lot had I covered everything. Be warned however!!!! Law, especially European, is not static but rather depends upon interpretation. Although I strongly believe that according to law the interpretation should be such so as to reach the conclusions that I have, a court may have a different opinion. As I said again, it is not an easy reading all the way down and for general purposes I would recommend to read Sam Pettus’ Emufaq which is a more relaxed text with more general information, despite the fact that it is US law centered. If you would like however to read a more “legal” and “technical” document and, especially if you are a programmer, see the legal status of some actions, then I think that this is your “book”, regardless of being or not a European citizen. The text is presented in electronic form, exactly as it was submitted to the University of Newcastle-Upon-Tyne, England in September 2000, but for this introduction.

You **may** download and host this file in your site without obtaining a permission, but it would be nice to send me an email at takist@netscape.net just to let me know and keep track. Questions, suggestions and objections should also be addressed at the same mail, although I am a frequent visitor of [JoseQ’s](#) message board with the name “Takis”. You **may not** copy, publish, translate, transform or exploit in any sense, commercially or otherwise, parts or the entirety of this document without my express written **in paper** consent or by acknowledging the source if it is for reference purposes, **nor** should you change this file in any way.

Takis Tsiricos, October 1st, 2000

OverClocked #20 “And The Winners Are...”

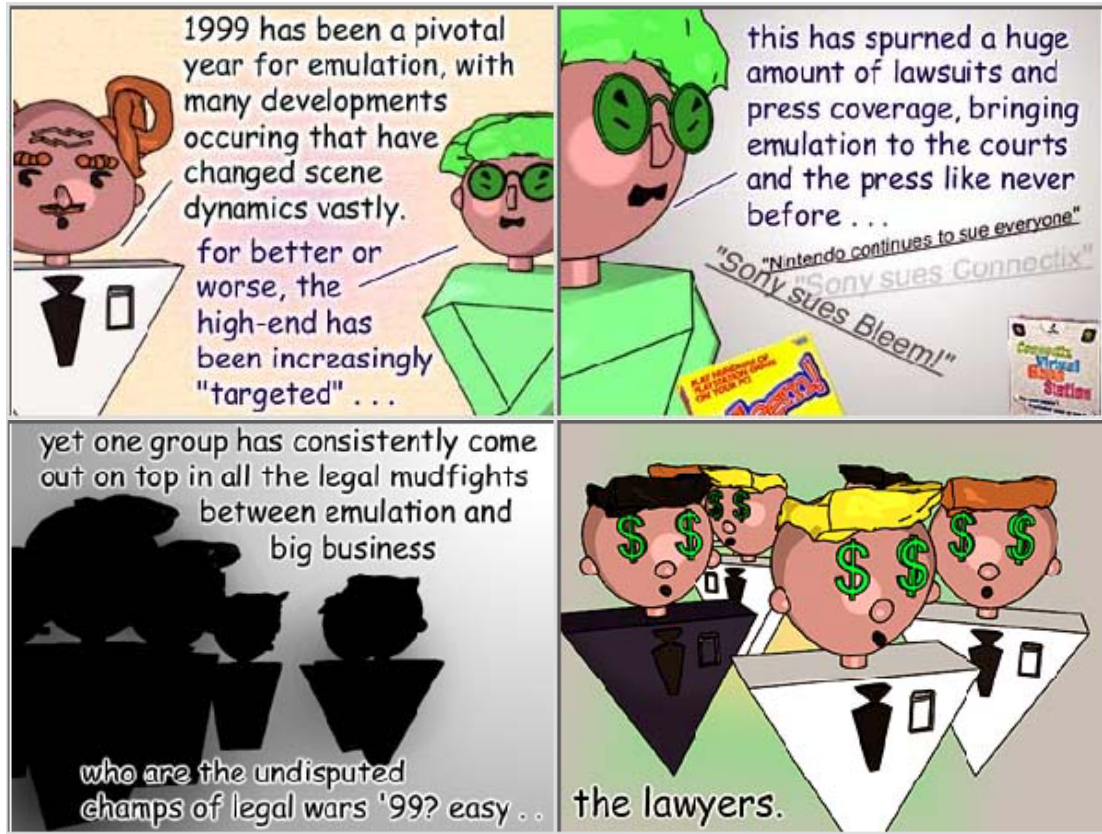

I would like to thank David Lloyd for permitting me to publish his strip.
OverClocked #20 “And the Winners Are...”
First published @ <http://www.overclocked.org/>.
All Rights Reserved © David Lloyd 1999

Contents

[An Introduction for the Emulation Community](#)

OverClocked #20, “And the Winners Are...”, by David Lloyd

[Contents](#)

[Glossary of Abbreviations](#)

[Glossary of Computer Terms](#)

[Preface](#)

[Chapter I](#) : The Background of Emulators

[Chapter II](#) : The Question of Emulators

[Producing an Emulator](#)

[The General Law](#)

[Chapter III](#): The Law in Relation to Emulators

[An Alternative View to Emulation](#)

[Chapter IV](#): Emulators in the Court of Law

[Chapter V](#) : Roms, Emulators, the Industry and Some Thoughts

[Trip and Fall: Instead of an Epilog](#)

[Table of Cases](#)

[Bibliography](#)

[Textbooks](#)

[European Legislation](#)

[UK Legislation](#)

[International Legislation](#)

[Journals](#)

[Case Reports and Briefs](#)

[Reports and Press Releases in the World Wide Web](#)

[Videogame Emulation News Websites](#)

[Videogame Emulators Home Pages](#)

[Lexicons](#)

[Appendices](#)

[Appendix I](#) - Game Consoles Related Materials

[A Typical Console](#)

[A Typical Cartridge](#)

[Appendix II](#) - Arcade Cabinets Related Material

[A Typical Arcade Cabinet](#)

[A Typical Cart](#)

[Schematics of a Cart](#)

[Appendix III](#) - Technical Specifications

[Atari Jaguar Console Specifications](#)

[Nintendo GameBoy Colour Specifications](#)

[Appendix IV](#) - Statistics

[Appendix V](#) - The Software Directive

Glossary of Abbreviations

API: Application Programming Interface
ASIC: Application Specific Integrated Circuit
AT&T: American Telephone and Telegraph Company
BASIC: Beginners All-Purpose Symbolic Instruction Code
Berne Convention: Berne Convention for the Protection of Literary and Artistic Works, 1971
BIOS: Basic In/Out System
COBOL: Common Business-Oriented Language
CDPA 1988: Copyright, Designs and Patent Act 1988
CD-ROM or CD: Compact Disk Read Only Memory
CPS1: Capcom System 1
CPS2: Capcom System 2
CPU: Central Processing Unit
DVD: Digital Versatile Disk
EC: European Community
EEPROM: Electrically Erasable Programmable Read Only Memory
E.I.P.R.: European Intellectual Property Review
EU: European Union
FAQ: Frequently Asked Questions
FTP: File Transfer Protocol
GATT: General Agreement on Tariffs and Trade, 1994
GPU: Graphics Processing Unit
GTE: Geometry Transfer Engine
GUI: Graphical User Interface
IBM: International Business Machines, Inc.
MAME: Multiple Arcade Machine Emulator
MAME32: Multiple Arcade Machine Emulator 32-bit
MS-DOS or DOS: Microsoft Disk Operating System
NES: Nintendo Entertainment System
Next-Gen: Next Generation Emulators
OJ: Official Journal
OS: Operating System
PC: Personal Computer
PROM: Programmable Read Only Memory
PS1: Playstation 1
PS2: Playstation 2
RAM: Random Access Memory
ROM: Read Only Memory
ROM Image or Rom: Read Only Memory Image
Semiconductors Directive: Council Directive 87/54/EEC on the Legal Protection of Topographies of Semiconductors Products, OJ 1987 L24/36
SNES: Super Nintendo Entertainment System
Software Directive: Council Directive 91/250/EEC on the Legal Protection of Computer Programs (OJ 1991 L122/42)
TRIPs: Trade Related Aspects of Intellectual Property Rights
UK: United Kingdom
UltraHLE: Ultra64 High Level Emulator

URL: Uniform Resource Locator

US: United States of America

VGS: Virtual Game Station

VNC: Virtual Network Computing

WIPO Treaty: World Intellectual Property Organisation Copyright Treaty, 1996

Glossary of Computer Terms

Application Programming Interface (API): A Technical Interface.

Arcade Cabinet or Coin-Up: A compact, self-adequate Videogame Cabinet found at Amusement Halls.

Assemble: To translate a program written in Low-Level Language to Machine Language.

Basic In/Out System (BIOS): A set of programs, usually in firmware, that enables each computer's central processing unit to communicate with printers, disks, keyboards, consoles and other attached input and output devices.[#]

Binary Digits: the "1"s and "0"s electricity switches which represent instructions in Machine Language.

Central Processing Unit (CPU): Refers either to the principle microchip that the computer is built around (such as the Pentium or PowerPC chip) or the box that houses the main components of the computer.*

Compile: To translate a program written in High-Level Language to Machine Language and vice versa.

Cross-platform Compatibility: Compatibility between different Operating Systems.

Decompile: To translate a program written in Machine Language to High-Level Language.

Disassemble: To translate a program written in Machine Language to Low-Level Language.

Electrically Erasable Programmable Read Only Memory (EEPROM): A variation of Read Only Memory.

File Transfer Protocol (FTP): File Transfer Protocol. Allows users to copy files between the local system and any system reachable over a network. A common way to make software (text files, sounds, pictures, utilities, etc.) available is to put it on an anonymous ftp server. Anonymous ftp servers allow users to login without a password, specifying "guest" as the user, and then copy whatever has been made available.*

Firmware: Programs written permanently into ROM chips.*

Game Console: A Videogame Console intended for home use, usually coming without a monitor since it is to be attached to a television, which comes with a choice of peripherals.

Graphical User Interface (GUI): A way of interacting with a computer, based on graphics instead of text. GUIs use icons, pictures, and menus, and use a mouse as well as a keyboard to accept input. Windows9x for example use a GUI while MS-DOS does not.*

Hardware: The physical pieces of equipment in a computer system. e.g. monitor.+

High-Level Language: A programming language which is relatively remote from the computer's Machine Language, whose statement is equivalent to several Machine Language instructions. E.g., BASIC, Pascal, COBOL, C.+

Low-Level Language: A programming language which is very close to the computer's Machine Language, whose statement has only one direct equivalent in Machine Language.+

Machine Language: The set of instructions and statements which control the computer directly.+

Object or Binary Code: Where the code of a program is in Machine Language.

Operating System (OS): A program or set of programs which control and organize the operation of applications programs in addition to managing memory and providing certain facilities such as loading, saving and deleting. E.g., Windows9x, UNIX, MS-DOS.+

Programmable Read Only Memory (PROM): A variation of Read Only Memory.

Random Access Memory (RAM): The memory that can be used by applications to perform necessary tasks while the computer is on. Memory chips that can hold easily changed information as long as there is an electric current running through them, but go blank when the electricity is cut off. The term "Random Access" refers to the ability of a processor to immediately access any part of the memory.*

Read Only Memory (ROM): A chip or chips with information- usually a program-written into them at the time of their manufacture. These chips cannot be re-written, hence "read-only." The contents of ROM remains even when the computer is turned off.*

Read Only Memory Image (ROM Image or Rom): The exact copy (mirror image) of a Read Only Memory.

Source Code: Where the code of a program is in High-Level Language.

Technical Interface: The way which programs communicate with other programs or with hardware.

User Interface: The way that a user communicates with a program.

+: Either paraphrased or copied from the Glossary of Computer Terms of Bainbridge, D., “Introduction to Computer Law”, 4th Edition, Longman, 2000

#: Either paraphrased or copied from Sunderland University, “Standard Computer - Term Glossary”, available @ <http://blake.sunderland.ac.uk/~ta5wpr/computer.htm>

*: Either paraphrased or copied from the University of Chicago Campus Computer Stores, “A Glossary of Computer Related Terms”, available @ <http://www-ccs.uchicago.edu/technotes/misc/Glossary/>

Preface

The idea of writing a dissertation on the legal position of Videogame Emulators first occurred to me when I was at my senior year of my Bachelor's degree. Although it was my "love" for Arcades that provoked me in the first place, it was eventually the legal controversy which seemed to shroud Emulators that made me consider the topic seriously. I finally decided to postpone it and now I am presenting it as a Master in Law student.

This dissertation discusses the legal "standing" of Emulators and not the enforcement of law on Intellectual Property Rights. The purpose of this dissertation is not to familiarise the general reader with the concept of Intellectual Property Rights in general but rather to familiarise the Law Reader, already competent with the basic notion behind Intellectual Property Rights, with Videogame Emulators and the legal implications and questions that they might raise. Thus, the basics of Intellectual Property Rights are deliberately not covered and instead a more detailed analysis on technical matters relevant to Emulators is given. This decision was primarily based on two grounds. First, there are already far too many studies available regarding the functions of Intellectual Property Rights in general, those ranging from what is a copyright to who is the proper claimant. To repeat once again what so many have already exhaustively expanded upon would not be challenging; I therefore chose to elaborate upon a highly specialized sector of this set of laws instead on the whole of it. This decision led to the second, subsequent, ground. Though most people, apart from Readers of Law, are familiar with terms such as copyright, patent and trademark and what they stand for, few, or at least fewer comparatively, are familiar with the technical issues surrounding emulation. This knowledge however of technical facts is essential in order for one to comprehend the difference between a permitted act and a restricted act under Intellectual Property Rights. Furthermore, the technical knowledge provided in this dissertation will permit one to consider the facts and opinions presented to him and accept as valid or discharge as erred my approach. After all, the ultimate purpose of this dissertation is to stimulate the reader to create his own idea regarding the legal position of Videogame Emulators, for it is a matter

not explicitly covered by law, to which I am merely presenting my approach and opinion, rather than the non-existent legal facts, based on some general legal rules. A note should be made here, regarding the subjects covered in this dissertation. Many aspects relevant to the subject, such as copyright time-frames, competition law and the law of confidence are not well elaborated or mentioned at all. This omission was mandatory, given the restraining word limitation of this project. This however does not mean that this text “as is” is seriously incomplete; all major subjects have been covered and most subjects omitted, had they been included, would have just facilitated “completeness” rather than attribute something radically different to what it has already been included.

Given the fact that Videogame Emulation is a “practice” thriving through the use of the Internet, and that many people from different countries may be involved in one project, the [MAME](#) team for example “employing” one hundred people for at least ten different countries, I concluded that using one single country’s legal framework would be “unfair”, in the sense that it implicates people from far more jurisdictions than just one. Similarly, for a question as focused as the one that we are presented with, International law in the sense of the [Berne Convention](#) and [WIPO Agreement](#) is excessively general and cannot accommodate as “prime” source of Law but rather as complementary where needed. I therefore concluded that the only suitable option was European Community Legislation. Apart from the fact that European Community Legislation has an “International” character, I found it to be most appropriate for both this project and [MAME](#), what I consider as one of the best Videogame Emulators, are projects conducted within Europe. The country which shall provide the implemented “European Law” where needed, both at statutory and at case law level, is England, while occasionally reference is drawn to the United States of America. Reference to this “foreign” law is acceptable for a number of reasons. On legal grounds, the relevant US and EC legislations have similar or identical wording for most of the provisions covered, probably by reason that both are bound by the same International Agreements, i.e. the [Berne Convention](#) and the [WIPO](#) Treaties. Secondly, at least where EC law does not explicitly state something contrary, it is advisable to cite US case law for more cases on the relevant subject have been brought forward within US jurisdiction; US law however is used in the context of speculation and suggestion since it is only binding to courts within the US jurisdiction.

Due to the idiosyncrasy of the subject, not many books were useful for they sought mainly to address the law “as is”, rather than hypothetical implementations. This uncertainty and speculation is clearly reflected in the bibliography; it consists of two legal “textbooks” in order to provide me with the legal facts and some fifteen articles in order to evaluate some contrasting views. On the other hand, original documents of the European Commission and other legal texts have been used extensively. The technical nature of emulation is addressed mainly by empirical study and knowledge, accumulated during the last three years that I first discovered Emulators, while many URL addresses of emulation-related websites are included, both for the benefit of the reader and because my accumulated knowledge derives up to a large extend from a synthesis of their contents.

Finally, a note should be made here regarding the language used in this work. Admittedly, bad language is often used, something considered unacceptable for a dissertation on the subject of Law. This bad language however is the correct terminology with reference to many of the aspects of this highly technical subject. Thus, one should come into terms with it and accept it as the appropriate “jargon”. On the other hand, the Oxonian approach to the orthography of Hellenic words is preferred rather than the Latinised equivalent, since the former is closer to the original one. In other words, if you are reading the WordHTML edition of this dissertation, better switch off the orthography citation.

The author would like to thank Roy McDonald, CEO of [Connectix Corporation](#) and Vickie Feeman, Attorney-at-law working for Howrey and Simon Silicon Valley office of Howrey & Simon in Menlo Park, California, currently defending Connectix’s case, for their assistance on legal matters, Dimitio Spentzas, TRZY, Dan Boris and [JoseQ](#) for their assistance on technical matters and Sylvia G. Panas for her support.

I have sought to state my opinion on the basis of materials available to me on 1 August 2000.

Takis Tsiricos
University of Newcastle Upon Tyne
Newcastle Upon Tyne, September 2000

Chapter I: The Background of Emulators

By reading the title on the cover, one must have formulated at least one question in his mind; what is Emulation and what is an Emulator? Emulation is a word defining an “art” used in many contexts; we however shall focus upon computers emulating Game Consoles and Arcade Cabinets.

In the general context, an emulator is a product “designed to imitate one system with another so that both accept the same data, execute the same programs, and achieve the same results”¹ and can be either entirely software based or hardware based or a combination of both hardware and software. The concept of Emulation has its roots back in 1964, when Larry Moss, a systems engineer of International Business Machines, Inc (IBM), developed an emulator by combining hardware and software in order to enable the more technologically advanced IBM System/360 to be able to work with the older IBM 7070 mainframe computers. The purpose was to create “backwards” compatibility where normally was not possible, due to fundamental differences between the two systems. This kind of emulation is alive even today, where a user of a “Wintel”² platform and licensee of a software named [Caprice](#) can turn his computer into an Amstrad 6128 running BASIC 1.1, other programs doing exactly the same things for other platforms such as Amiga 2000 and Commodore 64. Similarly, under a program called SoftWindows developed by [Insignia Solutions Inc.](#), Macintosh users can run the Windows platform and Windows-based programs, while with [Virtual Network Computing](#) (VNC), developed by the American Telephone and Telegraph Company³ (AT&T), cross-platform compatibility over networks is achieved. This, in other words “compatibility” where it is normally not possible, is our subject but concentrated to Game Consoles and Arcade Cabinets, summarily referred to as Videogames Emulation⁴.

¹ The American Heritage Dictionary of The English Language, 2nd College Edition, Houghton Mifflin Company.

² Wintel is the most common platform of a computer nowadays, running Windows Environment on an Intel based machine.

³ The author strongly recommends this free software, available @ <http://www.uk.research.att.com/vnc>

⁴ Although the term “videogame” is usually relates to Game Consoles, it may nevertheless be also used in the context of Arcade Cabinets too.

A Game Console is a piece of hardware for home use which is usually connected to a television and enables one to play games⁵. The most recent Game Consoles are Dreamcast of Sega Enterprises Ltd, Playstation of Sony Computer Entertainment, Inc and Nintendo 64 of Nintendo of America, Inc, while, for those who have memories from the 1980's, a perfect illustration is the Atari⁶ consoles, e.g. Atari 2600. An Arcade Cabinet, also referred to as "coin-up"⁷, is a piece of hardware dedicated to games which one may find in Amusement Halls or Snooker clubs and comes with a monitor by itself; Pac-man and Space Invaders are perhaps the two best known games, originally, for Arcade Cabinets⁸. Both Game Consoles and Arcade Cabinets, apart from the hardware that one interfaces with, i.e. monitor, controllers etc, have a "slot" for changing games. Although with Games Consoles this can be done by everyone since the slot is an external one, with Arcade Cabinets this requires a person with some familiarity with the hardware, usually a technician. The software for all Game Consoles, up until recently, came in the medium of a "cartridge"⁹, while now some manufacturers have opted for the medium of Compact Disks¹⁰ (CDs). Arcade Cabinets' software on the other hand comes in the medium of large boards of circuits, called "carts". Console cartridges are essentially the same thing as the carts of Arcade Cabinets, i.e. the software is contained on a board of circuits, only smaller and in a protective case¹¹.

So what is a Videogame Emulator¹² and what does it do? An Emulator is a computer program that "emulates" a hardware. In other words an Emulator is a program which makes a computer or other programmable electronic devices¹³ function as if they were the Game Console or Arcade Cabinet in question. Although many Emulators exist for almost all of the systems that have ever been developed, ranging from Atari, Super Nintendo Entertainment System (SNES) and Sega Megadrive 16-bit Consoles to Capcom Entertainment's System 1 (CPS1) and SNK Corporation of America's Neo-Geo Arcade Cabinets, it would facilitate our

⁵ For an illustration, see [Appendix I](#).

⁶ Now bought by [Hasbro Interactive, Inc.](#)

⁷ The name derives from the fact that you insert coins in order to gain credits (Ups).

⁸ For an illustration, see [Appendix II](#).

⁹ E.g. All Atari and Nintendo consoles, Including Nintendo 64.

¹⁰ E.g. Dreamcast, and PlayStation 1 & 2.

¹¹ A comparison can be drawn here between tape-bands and cassettes.

¹² The word Emulator hereinafter is used solely in the context of this dissertation, i.e. in relation to Arcade cabinets and Game Consoles, unless otherwise specified.

¹³ E.g. the [MAMED Kodak](#) Emulator, a MAME port, working on a Kodak .mpeg Camera.

discussion for one to remember [Virtual Game Station](#) (VGS), of Connectix Corporation and [Bleem!](#), of Bleem LLC, both Emulators of Sony's PlayStation 1, the [Ultra64 High Level Emulator](#) (UltraHLE) of Epsilon and RealityMan¹⁴ which emulates the Nintendo 64 Console and Nicola Salmoria's [Multiple Arcade Machine Emulator](#) (MAME) which currently, at release 37 beta 5, supports 2240(!) Arcade Cabinet games from "Multiple" different companies¹⁵. If a user loads into his computer an Emulator, e.g. [MAME](#), his computer automatically behaves and functions as an Arcade Cabinet. By running a game for the Cabinet, it is automatically self evident that the computer behaves as a Cabinet; the skylines and analysis of the screen resolution are those of a Cabinet's monitor and not those of a computer's and the game will not start until coins are inserted. Exactly the same is the situation with Emulators of more sophisticated and up-to-date Game Consoles, also referred to as "Next Generation" (Next-Gen) Emulators, such as the [VGS](#) and [UltraHLE](#).

This leads to the subsequent question of software, i.e. the games, although the legality of Emulators and the legality of software for Emulators is a totally different question without the legal status of the former being interdependent by that of the later and vice versa¹⁶, the answer of which is based upon different considerations as we shall later discuss. As it has been mentioned above, software usually comes in two mediums; boards of circuits, either contained in a cartridge or in the form of carts, and CDs. While generally speaking no problem rises from the fact that one can "misplace" a Playstation CD-ROM in a computer preloaded with either [Bleem!](#) or [VGS](#) instead of placing it in a Playstation Console, the case is not the same with regards to carts and cartridges. As there is no compatible slot available in a computer, similar to a CD drive, in order to place the board, the board must be transferred to a medium compatible with the computer's "slots", e.g. CD and Hard Disk drive. This process of transformation is characterized as "dumping", because a specially designed "reader" is attached to the board and by reading the information contained in its circuits it "dumps", in the form of a file, the "image", i.e. the properties of the board, that image been called "ROM Image" or "Rom"¹⁷. Thus, the ROM Image contains

¹⁴ The authors of [UltraHLE](#) are only known by their pseudonyms.

¹⁵ E.g. Capcom, SNK and Bally/Midway.

¹⁶ According to the Amstrad precedent, discussed in Chapter V.

¹⁷ The reader should take caution not to confuse a Rom (Image) with a ROM, the acronym for Read Only Memory, for the two are later used in a different context. Although the correct citation for

the dumped information of the board and it is an exact “image” of the board’s instructions but in a “computer-friendly” format. A parallelism, in order perhaps to assist the reader so as to comprehend, can be drawn here with the .mp3 audio format used by computers, which is usually encoded .wav format¹⁸. If a song in .cda format, .cda being the standard format for all Audio CDs, is transferred to the Hard Disk of a computer, the file upon transfer will have to change from .cda, the Audio CD format, to .wav, the equivalent computer audio format, in order to be readable by the computer. This process of transferring an Audio Track (.cda) to a Hard Disk (resulting .wav) is called “ripping”¹⁹. Ripping and Dumping, Rom Image and .mp3 and Emulators and .mp3 players²⁰ are thus describing same things on different subjects.

Having given a brief technical analysis on Videogame Emulators and hopefully assisted the reader who has not got a visual representation of an Emulator to familiarise with the issue, the following question to address is the motives behind Emulation. The reasons behind writing an Emulator are many but, unlike to what most would expect, one of those is usually not profit. In fact, most of the Emulators, including the best in terms of software compatibility and performance, but for the distinct exceptions of [Bleem!](#), [VGS](#) and [NO\\$GMB](#)²¹, are “freewares” widely distributed over the Internet. The two major reasons for writing such a program that I identified from the first moment I “discovered” Emulators are nostalgia and the satisfaction of developing a prima facie “impossible” program²². Although the argument of nostalgia might be difficult to apply to hardware and games released as late as 1999, this being the case with Playstation and Nintendo 64 games, one has to acknowledge that the reason why Emulators were programmed in the first place was to “revive” systems long “extinct”. Finally, if one is to give a historical perception,

Images is capitalized, for a Rom is the digital file Image of ROM, small letters will be used instead in order to prevent the abovementioned confusion.

¹⁸ This difficult technical example might assist the reader, since the .mp3 “phenomenon” has been recently documented by the media extensively, especially in relation to the [Napster](#) and [MP3.com](#) service providers and their pending trials.

¹⁹ In better English it is called “Audio Extraction”. The etymology of “ripping” is probably “to rip-off (a CD) from its files.

²⁰ E.g. the software player for Windows “[WinAMP](#)” and the hardware player “Rio”. In effect, Rio is a walkman capable of .mp3 playback

²¹ It is supposed to be read as “No Cash GameBoy” and it is a GameBoy Colour Emulator from Martin Korth of Nintendo’s handheld system. There are currently more than fifty Emulators in total so some are bound to be forgotten or not even known by the author.

²² The idea of emulating videogames is very old; the success in doing so however is of the last eight years. It was thought after 1996 that the “mass” Emulators programming began. Originally the idea was characterized as “impossible”, partly because of the then low specifications computers.

Emulators can be argued as being the means by which obsolete videogames can be preserved, without the need for either the massive storage rooms or the delicate handle that the actual Cabinet/Console and Cart/Cartridge would require. The British Film Institute, probably acknowledging the historical perspective, as from 1997 started archiving videogame titles.

The above mentioned, the reader's attention should be now brought to the difference between emulation and simulation. Perhaps some would remember that around 1996, a software company called Accolade released a "game pack" containing the titles "Bubble Bobble" and Bubble Bobble 2, better known as "Rainbow Islands". Other titles, such as "Puzzle Bobble" followed. Those in effect were simulations²³. Instead of faithfully reproducing the original game, they were merely trying to create the same effect. Needless to say that the difference between the original games and their "computer" versions was disappointingly obvious. As it is stated in the "Novice Help Area" Article of [Amiga Emulation Zone website](http://www.amigaemulation.com/novice/whatisemu.asp)²⁴, "If someone writes a game that looks JUST like Pac-Man and even plays like Pac-Man but doesn't use the original program code for Pac-Man and recreate the actual hardware through software (chips, system board, control interfaces, etc) that Pac-Man program ran on - then that person has written a Pac-Man "simulator"- not an "emulator"²⁵.

Despite the fact that there are many good uses for emulators and that as a general rule emulators are a legal, beyond doubt, mean used and applied by the industry itself²⁶, with regards to Videogame Emulators in particular some considerations are present. Those, as we shall now discuss, rise in the context of Intellectual Property Rights.

²³ Technically speaking they were "ports".

²⁴ <http://www.amigaemulation.com/novice/whatisemu.asp>

²⁵ By "use the original program code", it is meant the original program code of the game, not the system's. Discussed later.

²⁶ Along with the examples mentioned earlier, one should add Microsoft Corporation's release of the Z80 Softcard in 1980. This product was a plug-in card accompanied by software that enabled Apple II Personal Computers to run the "rival" CP/M Operating System, the predecessor of IBM's dominance in the market. There is also suspicion (unconfirmed) due to technical considerations that Final Fantasy VIII, a game for Playstation ported upon authorisation for PC, was in fact running on an Emulator.

Chapter II: The Question of Emulators

Videogames, Consoles or Arcades, are classified under law by logic, in the absence of another classification, as computers. Judge Canby, of the United States Court of Appeals for the Ninth Circuit, while submitting his opinion in [Sony Corporation of America v. Connectix Corporation](#)²⁷, referred to the Playstation Console as “essentially a mini-computer” and this comment is accurate, since all Consoles and Arcade cabinets work with technology either identical or similar to those of computers²⁸. This approach is further strengthened by the fact that companies such as Sega and Sony have released the Dreamcast and Playstation 2 Consoles respectively, with attributes such as Digital Versatile Disk (DVD) playback and Internet connectivity, functions which one would anticipate rather from a computer and not from a plain “console”. For those reasons it is perfectly normal that reference to computers is made and that terms familiar to computers and computers as such are used in the context of this dissertation.

Videogame Emulators, as it has been previously mentioned, can be technically divided into two categories; Arcade Cabinet Emulators and Game Console Emulators. For the purposes of law however, it is preferable for one to treat them the same. This is so because similar reasoning and technology applies to both categories. For example, [MAME](#), an Arcade Cabinet Emulator, and [VGS](#), a Console Emulator, were both designed so in order to emulate instructions given by hardware and load programs written for that particular hardware. To succeed in doing that, the authors of the respective programs in both circumstances had to study the original system and then write their own program. A synopsis of the “production” process should be given here, in order for the reader to be able to comprehend how the law works and where the fine line between an act in violation of Intellectual Property Rights and a permissible act is drawn.

²⁷ Sony Corporation of America v. Connectix Corp., 203 F. 3d 596 (9th Cir. 2000) at 1704.

²⁸ E.g. common Central Processing Units (CPU) such as the Z80, “slots”, such as CD drives, and use of BIOS (see Note 29). For a person with knowledge of the computer hardware it would be of interest to look at [Appendix III](#) provided as an example.

Producing an Emulator

Although everyone accepts that software is code put in a given order, few perhaps would realize that what we traditionally consider as being hardware, apart from the nuts and bolts, is in essence software. A cart, for example, might be full of wires, conductors and pins but inside this “hardware” are contained instructions regulating the function of the whole system. Those instructions are essentially a program. A very accurate, and relevant, example is the BIOS²⁹. A BIOS contains information, usually in the mode of a program, and is located in a ROM³⁰ chip. This software hybrid is also called “firmware”. Furthermore, in order to speed up the processing speed, those instructions can be literally “hardwired” onto a chip, an example being the Application Specific Integrated Circuits (ASICs). The reader must thus come into terms with this “software-ish” nature of the hardware surrounding him and to his assistance, if the explanation and examples provided above were not to his satisfaction, are Article [1\(2\)](#) of the Software Directive³¹ and *Mars (UK) v Tecknowledge*³².

Then question then is, how can one gain access to this information, i.e. the code. Machines, no matter how complicated they become or evolve, save for the not so frequent truly pioneering revolutions, are simple to their basis and operate in a given manner. A widely understood example is the automobile which, after so many years of evolution and the transition, for example, from a maximum speed of 50 mph to 150 mph, still relies on a shaft and four wheels in order to operate effectively. Similarly, in order for any computer to comprehend the instructions given to it, be it a new one or a very old one, those must be in Machine Language which does nothing more than regulating “electricity” switches, “I” being for on and “O” being for off, “I”s and “O”s being referred to as binary digits. The question then should be how is it

²⁹ Basic In/Out System

³⁰ Read-Only Memory. Due the development of technology, PROM (Programmable ROM) and EEPROM (Electrically Erasable Programmable ROM), also known as FLASH BIOS, is now also available

³¹ As it is commonly named. [Council Directive 91/250/EEC on the Legal Protection of Computer Programs \(OJ 1991 L122/42\)](#)

³² (unreported) High Court, Chancery Division, June 11, 1999. The Directive provides that it applies to computer programs regardless of form, [Recital 7](#) specifically mentioning “in hardware form”, while *Mars v Tecknowledge* raises the issue of violation of copyright with respect to an EEPROM. Although, the case cited does not provide with a literal answer as to whether software can come in the medium of hardware, one can logically deduct this conclusion beyond doubt since an EEPROM is exactly that.

possible for one to program a computer. Although a programmer can write his program directly to Machine Language or a Low-Level Language³³ this is rarely how it is usually done nowadays, for it is extremely difficult without any real advantage for most purposes as compensation. Instead, most programmers use High-Level Language in order to write a program, such as BASIC, Pascal and C, the benefit being that High-Level Languages have a “comprehensible” structure based on a mixture of English words and mathematical formulas, containing commands such as “GOTO” and “IF X=10 THEN FD10”³⁴. Once a programmer is finished with his program written in a language other than Machine Language, this programme being called the “source code”, he then assembles it, in the case of a Low-Level language, or compiles it, in the case of a High-Level Language, i.e. transforms it, into “object code”, i.e. a program written in Machine Language, in order for his program to be understood by computers. The object code is said to be in binary format for it is a command string of “I”s and “O”s and it is in this form that programs are usually distributed to the public.

The task of a programmer writing Emulators is to create a program resembling the functions of a system. Acknowledging that, one anticipates that the programmer needs to comprehend the original program in order to be able to write his own. In order to do this, the programmer must have the original program in a format understood by him, i.e. he must have the source code of a program³⁵. Obtaining the source code of a program can be done in two ways; either the person or company holding the copyright to the program can release the source code in order to assist programmers to write programs compatible with their programs, an example being Microsoft in relation to the Microsoft Disk Operating System (MS-DOS or DOS) and the Windows Operating System’s Application Programming Interface (API)³⁶ and AT&T in relation to the UNIX Operating System, or a programmer, through the use of suitable hardware and software, can decompile/disassemble the object code in

³³ A Low-Level Language resembles Machine Language a lot; each instruction has a direct equivalent in Machine Language. Most old Arcade Cabinets and firmware are written in Low-Level Language but this is of no significant importance.

³⁴ The first command is in BASIC while the second one is in LOGO. Those are of the very few commands that the author can remember from his years as an elementary pupil. A command in a High-Level Language may correspond to more than one instructions in Machine Language.

³⁵ Thought this is the case for most Emulators there are also alternative ways of producing an Emulator, some of which are examined under the subchapter “An Alternative view to Emulation”.

³⁶ API is a Technical Interface, meaning the way that a program communicates with the computer. Further analysis later.

order to obtain the source code. Those are acknowledged technical necessities and cannot be circumvented, their application of course being far wider than in the context of Emulators only. For example, the mere fact that Windows9x is the Operating System which most computer users have installed in their computers, should prove to be a reasonable ground as to why programmers, others than that of Microsoft's own, want to write applications compatible with Windows.

The legal problem of course is self evident. Computer programs, being considered by Article [1\(1\)](#) of the Software Directive as “literary works”³⁷ are entitled to copyright protection, meaning that one cannot simply copy the code of a program and under a new name claim that he has a program of his own. Although the notion behind copyright is as simple as that, the law provides a far more detailed analysis on rights, restricted acts and exclusions upon which we shall now elaborate.

The General Law

Computer Programs, being considered as literary works under law, are afforded the protection of copyright. Although the term Intellectual Property Rights also includes, apart from copyright, trademark and patent, trademarks are usually not violated by Emulators for they are not used at all³⁸ while computer programs are rarely granted a patent certificate in order to be able to afford such protection in the first place³⁹. Furthermore, it is more difficult and time consuming for a claimant⁴⁰ to establish a patent infringement than it is to establish a copyright infringement and thus

³⁷ Within the context of Article 1 of the [Berne Convention for the Protection of Literary and Artistic Works](#), 1971, hereinafter referred to as “The Berne Convention”. There are some arguments as to whether computer programs can be characterized as literary works under the Berne Convention, since it was not drafted with computer programs in mind. In any event, this is rather an academic argument since under Article 4 of the [World Intellectual Property Organisation \(WIPO\) Copyright Treaty 1996](#), hereinafter referred to as “The WIPO Treaty”, “Computer programs are protected as literary works within the meaning of Article 2 of the Berne Convention”, the Treaty being a special agreement and thus allowing modifications to the Berne Convention, within the meaning of Article 20 of the Berne Conventions. Furthermore, Article 10 of the GATT Uruguay Round Agreement on Trade Related Aspects of Intellectual Property Rights (TRIPs) 1994 states that “Computer Programs, whether in source or object code, shall be protected as literary works under the Berne Convention”. It is worth noting that all of the European Union Member States are members to all of the above.

³⁸ Most of the consoles, upon “power on” generate a trademarked logo. No Emulator generates that logo by reason that this instruction is always deliberately not included in the program.

³⁹ According to Article 52 of the European Patent Convention, a program is not patentable “as such”, unlike copyrightable, and may only be patented if it is of technical significance to a hardware and sufficiently inventive.

⁴⁰ As the term has changed from “plaintiff”, according to the Civil Procedures Rules, 26 April 1999.

the copyright “route” is preferred. Since the only available recent litigation is copyright-centred it is appropriate for us to concentrate upon copyright.

A creator enjoys copyright protection for the mere fact that he created something, without the need to comply with further formalities in order for his work to be protected by copyright⁴¹. For example, this dissertation is copyrighted by Takis Tsiricos simply because he went through the trouble of writing it. Since there is not one single European Directive or Treaty listing all the restricted acts, leaving this “consolidating” task for national implementing legislation, it is worth looking at the relevant English statute which serves as a typical example⁴². According to s.16 of the Copyright, Designs and Patent Act 1988⁴³, acts restricted by copyright, permissible only under the express authorisation of the copyright owner, are⁴⁴:

- a. to copy the work
- b. to issue copies of the work to the public
- ba. to rent or lend the work to the public⁴⁵
- c. to perform, show or play the work in public
- d. to broadcast the work or include it in a cable programme service
- e. to make an adaptation of the work or do any of the above in relation to an adaptation

In relation to our given subject, the applicable provisions are those of adaptation and copy. Adaptation, according to s.21(3)(ab) of the CDPA 1998 as amended⁴⁶, “in relation to a computer program, means an arrangement or altered version of the program or translation of it”, whereas translation, according to s.4 “includes a version of the program in which it is converted into or out of a computer

⁴¹ This is the case with most countries, including England.

⁴² Typical, for it complies at large with the [Berne Convention](#) and [WIPO Treaty](#) and the various relevant Directives.

⁴³ Hereinafter referred to as “CDPA 1988”.

⁴⁴ As laid down by Bainbridge, D., “Introduction to Computer Law”, 4th Edition, Longman, 2000, p. 16

⁴⁵ Section 16(b) was modified in order to cover all forms of copyright work and 16(ba) was inserted by the Copyright and Related Rights Regulations (SI 1996/2967), in order for the Act to comply with the Council Directive 92/100 on the Rental Right and Lending Right and Certain Rights Relating to Copyright in the Field of Intellectual Property, OJ [1992] L346/61.

⁴⁶ By reg.5 of the Copyright (Computer Program) Regulations 1992 (SI 1992/3233) in order to comply with the Software Directive

language or code or into a different computer language or code⁴⁷. Regarding copying, it is understood that literal, i.e. straightforward, copying without the copyright's owner consent is a restricted act; such examples being the products of software and videocassette piracy. The problem rises with respect to non-literal copying, for the purpose of copyright is to protect one's expression and not the underlying idea to that expression⁴⁸. This dichotomy of a work between idea and expression is reasonable for otherwise copyright law would produce adverse phenomena both at a social and technological level. For example, if we are to disregard the copyright expiry limits, scientists would not be able to study effectively the atom for it was first conceived as an idea and expressed by the Ancient Hellene Democritus⁴⁹, nor would for me to write this dissertation be possible because, at least in parts, it is based on ideas of others; the result would have clearly been disturbing. Emulators, as one might have anticipated, raise questions in the context of non-literal copying and not literal copying⁵⁰. To elaborate further on general principles of law would be futile; instead we shall proceed to examine Emulators under the prism of the Software Directive.

⁴⁷ e.g. from Pascal to COBOL or from Machine Language (object code) to another language (source code) and vice versa.

⁴⁸ Bainbridge, op. cit p. 31 states that "this is a direct consequence of the nature of copyright as set out in the Act." (meaning the CDPA 1988). This is anticipated, for Article 2 of the [WIPO Treaty](#) states that "protection extends to expressions and not to ideas, procedures, methods of operation or mathematical concepts as such". It is worth noting that England has not implemented this express dichotomy in the Act, however courts seem to do so as a standard practice of general principle of copyright law. See para. V.1.d of the [Report from the Commission to the Council, the European Parliament and the Economic and Social Committee on the Implementation and Effects Of Directive 91/250/EEC on the Legal Protection of Computer Programs, COM\(2000\) 199 final of 10 April 2000](#).

⁴⁹ This precise kind of reasoning is leading the author to disregard the US claims of patentability of the human DNA.

⁵⁰ See Bainbridge's discussion, op. cit. p. 35-37 on literal and non literal copying on the English cases of *IBCOS Computers Ltd v Barclays Highland Mercantile Finance Ltd* [1994] FSR 275 and *John Richardson Computers Ltd v Flanders* [1993] FSR 497, although they are only remotely applicable to Emulators.

Chapter III: The Law in Relation to Emulators

The Commission, wisely one may add, opted not to define the term “computer program” in the Software Directive, in order to refrain from accidentally excluding future technological developments⁵¹. The [Green Paper](#) put forward a broad working definition: “A computer program is a set of instructions the purpose of which is to cause an information processing device, a computer, to perform its functions”⁵². This broad definition, as it was mentioned above, is entirely in line with Article [1\(2\)](#) of the Directive which states that the Directive is applicable to computer programs regardless of the form in which they are expressed. In other words, prior to the Software Directive and based on the general applicable law, Emulators are infringing rights because the necessary acts that one has to perform in order to write one fall within the restricted acts, subject of course to any particular exclusions. The Software Directive however has “reinvented” law with regards to computer programs and thus one should examine it thoroughly in order to comprehend the current legal status quo⁵³.

The easier way to explain the law in relation to Emulators is by adopting a reverse approach. It is more convenient to examine first the exceptions of the law and then search for any inconsistencies with the rights conferred to the copyright holder, but for Article 1 which we shall refer to first.

Article [1](#) of the Software Directive, titled “Object of Protection”, is a repetition of the general applicable legal framework with the necessary references to computer programs. Article [1\(1\)](#) states that computer programs are to be protected by copyright as literary works, as those are defined by the [Berne Convention](#), including their preparatory design material, while Article [1\(3\)](#) states that protection is afforded to original programs, in the sense that the program is the author’s own intellectual creation, no other criteria being applied to determine the eligibility for protection⁵⁴.

⁵¹ As indicated in para. 1.1 of the Explanatory Memorandum to the original proposal, COM(88) 816 of 5 January 1988.

⁵² [Green Paper on Copyright and the Challenge of Technology, COM\(88\) 172 of 7 June 1988](#), para. 5.1.1.

⁵³ Articles irrelevant for our purposes are omitted. The entire Directive however is available at [Appendix V](#).

⁵⁴ In order to harmonise standards between Member States. For example, a computer program would have not been afforded copyright protection in Germany prior to the Directive, unless it was a

The dichotomy between expression and idea is expressly made in Article [1\(2\)](#) where “Protection in accordance with this Directive shall apply to the expression in any form of a computer program.” continuing that “Ideas and principles which underlie any element of a computer program, including those which underlie its interfaces, are not protected”. [Recital 11](#) explains that interfaces are called those parts of the program which provide with interconnection and interaction between elements of the software and hardware. To this definition one should give an explanatory note. There are two kinds of interface; the Technical Interface and the User Interface. The Recital defines the Technical Interface as it explains the interaction and interconnection between software and hardware, that also including the interaction and interconnection between software and software. Examples of Technical Interface are the “compatibility” between Windows 98 and “Pentium based”⁵⁵ Personal Computers and Adobe’s programs such as Acrobat with Microsoft’s Windows 98. On the other hand, User Interface refers to, as the term suggests, the interaction between human and an application program such as a word processor. For obvious reasons, only Technical Interface is of relevance to us, since the User Interface of an Emulator, by virtue of its nature, does not bear any similarities with that of the emulated program⁵⁶. What constitutes however the precise nature of an interface in legal terms? According to Downing⁵⁷, “An interface will be reflected in program code because the way in which that code is written will be determined by the interface rules or specification. For example, the interface specification might state that data must be sent at a particular speed or to a particular place. The interface specification does not necessarily have to dictate the actual code which is required to implement the interface”. This however leads back to the question as to what is protected and what it is not, i.e. the expression/idea dichotomy stated in Article [1\(2\)](#). It can be argued, by reason of Article 1(2), that the interface specification is outside the scope of copyright

creative achievement exceeding the average skills used in the development of computer programs as it is illustrated by *Sudwestdeutsche Inkasse KG v Bappert und Burker Computer GmbH* (1985) Case 5483, BGHZ94, 276.

⁵⁵ As oppose to Macintosh or ARM computers for example.

⁵⁶ One of course could argue that by Bleem and Connectix including the Graphical User Interface (GUI) of the on-screen menu of Playstation which facilitates the playback of Audio CD and memory card management, the discussion on User Interface would become relevant; neither of the Emulators however does so. Although the Directive seems to apply only for Technical Interfaces, See Kroker. E. R., “The Computer Directive and the Balance of Rights”, (1997) 5 E.I.P.R. p. 247 at 249, the “standardisation” of GUIs might be preferable, particularly with respect to computer applications, on social grounds. See Gordon, S., E, “The Very Idea!: Why Copyright Law is an Inappropriate Way to Protect Computer Programs”,(1998) 1 E.I.P.R, p. 10 at p.11.

⁵⁷ Downing, R., “Information Technology Law”, John Willey & Sons, 1995, para. 4.34 p. 89

protection. With regards to the code implementing those specifications, the views differ. Although one could say that the code is an expression of an idea one could argue, this being the case for most Emulators to the best of my understanding, that there is a merge of idea and expression, meaning that this code is the only way of expressing that idea and thus it is not protected by copyright⁵⁸. This uncertainty makes it imperative for us to proceed, assuming that the interface is copyright protected.

Article [6](#) of the Software Directive, titled “Decompilation”⁵⁹, is perhaps the single most important provision in the Directive with regards to Emulators. As it has been earlier submitted as a technical fact, most Emulators, e.g. [VGS](#), are depended on the study of the original program, and this program, software or firmware, is supplied by companies in object code form. Furthermore, again in accordance with what has been previously contested under the general law principles, for a software-based emulator⁶⁰, such as all the Videogame Emulators, to be a direct copy of all the instructions comprising a copyrighted program would be in violation of copyright. Given the considerations above, Emulator programmers are opting for the exercise of reverse engineering⁶¹ which enables them to reproduce the functional elements of a program, while at the same time not infringing the copyright of the program, if of course they manage to “reverse engineer” successfully⁶².

There are many ways for reverse engineering to be conducted, including⁶³:

⁵⁸ Note the different approaches considered in the US case of *NEC Corp v Intel* (1989) 10 USPQ 2d and the UK interlocutory hearing of *Microsense Systems Ltd v Control Systems Technology Ltd* (unreported) 30 March 1994.

⁵⁹ Or disassemble if he opts for a low level language. Although the Article is titled “Decompilation”, disassembling a program is also covered as it becomes apparent from the Article’s provisions. Because in law there is no difference between the two acts, the term “decompilation” will be used for all circumstances at an attempt to reasonably simplify matters. Do note however that England has erred seriously in interpreting the Directive, making specific provisions for decompilation only under s.50B CDPA 1988. This point is raised by the Commission. See para. V.6 of the [Commission’s Report](#), op. cit.

⁶⁰ In the sense of not being an emulator similar to Microsoft’s Z80 Softcard. See Note 26

⁶¹ To achieve same results through a different process. For example, both Intel and AMD chips are achieving the same results but are based on different circuitry and use different algorithms. Reverse Engineering applies more or less to every industry.

⁶² So as to comply with the test in *IBCOS Computers Ltd v Barclays Mercantile Highland Finance Ltd* [1994] FSR 275 cf. [Cantor Fitzgerald v Tradition](#) [2000] RPC 95. Even a small copied part might be deemed as “substantial” and thus infringing, if it is proved that the author spend substantial time and effort, according to *Electronic Techniques (Anglia) Ltd v Critchley Components Ltd* [1997] FSR 401. For an extensive conversation, see [Cantor Fitzgerald v Tradition](#), para. 73-80.

⁶³ Johnson-Laird, A., “Software Reverse Engineering in the Real World”, 1994 19 U. Dayton L. Rev. p. 843, at p. 846.

- a) Reading about the program
- b) Observing the program in operation by using it on a computer
- c) Performing a static examination of the individual computer instructions contained within the program
- d) Performing a dynamic examination of the individual computer instructions as the program is being run on a computer

In effect, observation (b) and examination (c and d), all of which mean that parts or the whole of an original program will have to be temporarily reproduced into a computer's Random Access Memory (RAM)⁶⁴, are more useful in understanding a program and examination (c and d), meaning that the object code will have to in addition be decompiled, is even more useful and thus preferred⁶⁵. As the reader must have understood by now, this is the exact point where Article 6 becomes relevant.

According to Article [6\(1\)](#), “the authorization of the rightholder shall not be required where reproduction of the code and translation of its form within the meaning of Article [4](#) (a) and (b) are indispensable to obtain the information necessary to achieve the interoperability of an independently created computer program with other programs”. Surely, this provision poses no problems for it describes the very nature of Emulators which is to achieve interoperability between a game console, for example, and its software with a computer Operating System, such as Windows9x, LINUX and Macintosh OS7. This right however, or better say exclusion from restricted acts, goes as far as obtaining information in relation to the Technical Interface and is subjected to the fulfilment of some further conditions.

Article [6\(1\)\(a\)](#) states that these acts, i.e. reproduction and translation must be “performed by the licensee or by another person having a right to use a copy of a program, or on their behalf by a person authorized to do so”. Again, this is not of immediate relevance to Emulators because most programmers either own the hardware or are given the hardware by owners for that particular reason. One however should note the following example; Connectix, in [Sony v Connectix](#), contested that at an early stage of their effort they downloaded an Image of the Papillon chip, the name of the Playstation BIOS, from the Internet. Had they based their study upon this copy, they would have been outside the scope of Article [6](#). For

⁶⁴ This is a very important point with regards to Article 4(1) later discussed.

⁶⁵ Note however the points raised later.

their good fortune, the Image turned out to be from a Japanese language version Playstation and was thus useless to them; the next day they bought a console, thus becoming rightful users. Article [6\(1\)\(c\)](#) serves as a reminder, stating that “these acts are confined to the parts of the original program which are necessary to achieve interoperability”.

Having obtained by decompilation the necessary fundamental information, an Emulator programmer builds the basic skeleton of his Emulator that behaves in a similar manner with the original system. The transition from the skeletal program to the final program is done by loading appropriate for that system software in his Emulator, e.g. a NES game for a NES emulator, and then studying the Emulator’s behaviour, mainly relying on the visual display of his monitor and some general principles of programming. Since creating an Emulator has as a prerequisite that one knows the behaviour of the system’s software in the first place, one understands that his Emulator has an error, referred to as bug, when for example he receives a blue background colour on a game that he knows that it was meant to be green. He then tries to “debug” his Emulator until the picture in his monitor looks exactly the same as it would look in the original system. If an Emulator performs correct with one software, it will perform correct with all the software designed for that particular system⁶⁶. This process cannot be deemed to infringe copyright for the result pursued maybe the same, i.e. the same response, but the process, and thus the expression, is different. One would hardly accept that a car for example is a “copy” of another car, simply because both cars can drive at the same speed with the same fuel consumption. Such a technique seems to be compatible with Article [6\(2\)](#) which deals with effective conditions on the resulting program, i.e. the Emulator. A programmer may not use the information obtained for purposes other than to achieve the interoperability of his Emulator⁶⁷, nor pass this information to others but for where it is necessary for the interoperability of his program⁶⁸. Emulators that are not open source, such as the [UltraHLE](#), [VGS](#) and up until recently [RAINE](#)⁶⁹, are not distributing any information

⁶⁶ This comes with few exceptions, especially where software has some additional instructions for the system imbedded in it, as in the case of some NES cartridges. This however is not the general rule and it would not serve our current purpose to analyse further.

⁶⁷ Article [6\(2\)\(a\)](#)

⁶⁸ Article [6\(2\)\(b\)](#)

⁶⁹ A now discontinued Emulator, mainly focused on Taito and Jaleco Arcade cabinets

at all while open source emulators, such as [MAME](#) and [Callus](#)⁷⁰, serve as providing information necessary to achieve interoperability between independently created programs, i.e. Emulators and potential “ports”, e.g. the Windows port [MAME32](#), or utility tools. Accordingly⁷¹, the resulting program, i.e. the Emulator, must not infringe the copyright of the original program, i.e. include portions of original code not relating to the interface, if this code is protected by copyright. The same of course would apply for translated code etc.

A very useful legal illustration regarding the legitimacy of the acts stated above is provided by the US case *Sega Enterprises, Ltd. v. Accolade, Inc.*⁷². The facts of the case were that Accolade, a game software manufacturer, wanted to built cartridges for use with Sega’s console “Genesis”. Sega was the sole author for software for the Genesis console. Accolade, in order to manufacture cartridges compatible with the Genesis console needed to find out the interface of the Genesis console, in order for its cartridges to be compatible with it. Sega was not granting the needed information to Accolade and so Accolade decided to obtain this information by the process of disassembly⁷³. The court approved this practice on the grounds of fair use, reasoning that disassembly constitutes fair use if it is the only means available for accessing the ideas and functioning concepts within “operating systems, system interface procedures and other programs that are not visible to the user when operating”⁷⁴. Bearing in mind that the US law does not provide with a provision similar to that under Article 6(1) of the Software Directive and thus a substitution between the “fair use” principle and the decompilation right is necessary, it is difficult to perceive how could a European court reach a different outcome regarding Emulators, especially when this decompilation right, by virtue of Article [9\(1\)](#)⁷⁵, cannot be derogated by contract, since the reasoning given by the US court fits the Directive’s provisions so well⁷⁶.

⁷⁰ A now discontinued Emulator from [Bloodlust Software](#) of CPS 1 Arcade cabinets. Callus is one of the oldest but still best Emulators available in terms of programming effort and compatibility.

⁷¹ Article [6\(2\)\(c\)](#).

⁷² 977 F.2d 1510 (9th Circ., 1992).

⁷³ In the given case, the act in question was that of disassembly and not decompilation; the difference is of no importance.

⁷⁴ *ibid.*, at 1520.

⁷⁵ “Any contractual provisions contrary to Article 6 or to the exceptions provided for in Article 5 (2) and (3) shall be null and void”. As a practical example, one could read the provision under clause 2 of Windows 98 licence agreement.

⁷⁶ Dawning seems to raise exactly the same point. See Downing, *op. cit.* para. 4.45, p. 92. Thought *Sega v Accolade* has been heavily criticised, this has been done in the course of dealing with

Having seen the effect of the decompilation provision, we must now proceed accordingly to the other relevant provisions under the Directive in order to address any potential inconsistencies or problems that they might give rise to.

Article [4](#), titled “Restricted Acts”, follows the same pattern with the general law of copyright. According to the preamble of Article [4](#), subject to the provisions in Articles [5](#) and [6](#) a copyright holder has the exclusive right to do or authorize:

[4\(a\)](#) “the permanent or temporary reproduction of a computer program by any means and in any form, in part or in whole. Insofar as loading, displaying, running, transmission or storage of the computer program necessitate such reproduction, such acts shall be subject to authorization by the rightholder”.

[4\(b\)](#) “the translation, adaptation, arrangement and any other alteration of a computer program and the reproduction of the results thereof, without prejudice to the rights of the person who alters the program”

Regarding Article [4\(a\)](#), one can spot an inconsistency to this provision at once, for it is a technical necessity for parts or the whole of all programs, regardless of Emulators, to temporarily reproduce themselves in RAM. This unique in the field of copyrighted works prerequisite for temporary reproduction, although it does not provide one with a copy that he can distribute, poses a great controversy. Although Article [5\(1\)](#) does allow such an act if it is “necessary for the use of the computer program by the lawful acquirer in accordance with its intended purpose, including for error correction” one should note that this is subject to the “absence of specific contractual provisions”. In other words, a rightholder could by contract restrict these acts. This however seems to contradict [Recital’s 18](#) opinion which forbids the “contracting-out” of running and debugging a program. Similarly, if such a prohibition was to be accepted, decompilation would become technically impossible⁷⁷ and thus, although not directly, Article [9\(2\)](#) forbidding the restriction of decompilation by contract would be circumvented. Most of the Member States,

competition law, e.g. See Lai, S., “Recent Developments in Copyright Protection and Software Reverse Engineering in Singapore – A Triumph for the Ultra-protectionists?”, 1989 5 E.I.P.R. Nobody has disputed this part of the judgment.

⁷⁷ As it has been earlier submitted, all decompilation techniques have as a prerequisite that code shall be copied to RAM.

obviously realising this implications, chose not to implement this particular paragraph at its full extend⁷⁸. The abovementioned reasons should prove adequate for the European Court of Justice to take the Recital's approach⁷⁹. Article 4(b) is straight forward and no problems seem to result from it. An Emulator will remain legal, as long as reverse engineering is conducted effectively and unnecessary portions of the original code or not included in it, either by adaptation, translation or other alterations. Programmers however, being aware of that fact, do not include such infringing elements in their Emulators or at least they allege so. Though one cannot be sure about the validity of this allegation unless the particular Emulator forms the subject matter of a trial or one compares the two source codes, the facts of [Sony v Connectix](#), the only relevant trial on this subject, seem to favour this allegation.

Article [5](#), titled "Exceptions to the Restricted Acts", has a similar effect with its equivalent in general copyright law, as one can assume from its title. As we discussed above, Article 5(1) serves as an exception to Articles' 4 (a) and (b) restricted by authorisation acts, proviso to specific contractual provisions. Our interest now then, should focus upon Article [5\(3\)](#) which states that "the person having a right to use a copy of a computer program shall be entitled, without the authorization of the rightholder, to observe, study or test the functioning of the program in order to determine the ideas and principles which underlie any element of the program if he does so while performing any of the acts of loading, displaying, running, transmitting or storing the program which he is entitled to do"⁸⁰. In the process of writing the Emulator and finalising it, a programmer will have to do most, if not all, of the above but that poses no problem, as Article 5(3) states that such actions can be performed without the authorisation of the rightholder and a similar proviso to that of Article [5\(1\)](#), i.e. "in the absence of specific contractual provisions", is not present. This right of study of course, similarly to the right of decompilation, cannot be derogated by contract, since a contractual provision contrary to that right would be null and void⁸¹. In essence, one could say that as Article 5(1) serves as the "excuse" for a user to copy a program into his computer's RAM in order to use it "in

⁷⁸ Among which, the UK. See para. V.4.a of the [Commission's Report](#), op. cit.

⁷⁹ See however Dixon, A. N. and Hansen, M. F., "The Berne Convention Enters the Digital Age", (1996) 11 E.I.P.R., p. 604 at p. 608 cf. Sir Anthony Mason, "Development in the Law of Copyright and Public Access to Information", (1997) 11 E.I.P.R., p. 636 at p. 638.

⁸⁰ Note that England has not included "which is entitled to do" in s. 50C of the CDPA 1988. This may have serious implications as the Commission notes. See V.5.c of the [Commission's Report](#), op. cit.

⁸¹ According to Article [9\(1\)](#).

accordance with its intended purpose”, i.e. to “run” the programme, Article 5(3) serves as the excuse for an Emulator programmer to copy the program, e.g. the BIOS instructions, into his computer’s RAM, in order for him to “to observe, study or test the functioning of the program...”.

Having discussed the above, one concludes that by writing an Emulator, a programmer does not infringe any of the rights of a copyright holder, provided of course that the resulting program does not contain infringing elements.

An Alternative View to Emulation

As we have discussed, the programming of an Emulator can be based on obtaining the necessary information by decompiling the “program” of the original system. This does not mean however that this is the only way that an Emulator can be programmed, and in fact the views of Emulator programmers and respected webmasters⁸² are contrasted as to which techniques are more frequently used. This kind of distinction however was deliberate on our behalf for it facilitates the legal analysis of Emulators. The alternative technique that we shall now elaborate upon is “document-based” and it does not necessarily require the decompilation of a program⁸³.

As we have previously discussed, the program contained in the hardware is decompiled in order to obtain information. What happens though when the needed information are already known or can be obtained somehow without decompiling the program? It is after all true that if you have the needed information in paper, you can simply program your computer to behave in a given manner. If a programmer knows that CPU A, when connected with pin X in the given manner Δ performs Ψ , he can virtually recreate the whole process of a system in program.

Unfortunately, it has been submitted to me that the method used, i.e. decompilation or documentation, is often a matter of preferable style and not of availability of means. This choice however, when information is available, is not an advisable act as we shall now see.

⁸² TRZY, Dan Boris and JoseQ, among others.

⁸³ By addressing this technique too, it does not mean that we have exhausted all possible techniques used; we have though examined the two most frequently used ones thus covering more than 90% of the existing Emulators.

Consider the following two situations:

The comprising parts of a system are all generic components such as the Motorola M68000, Hitachi's SH-2 and Zilog's Z80 CPUs, and thus their functions are considered as common knowledge. The Service Manual, containing schematic diagrams and other important information regarding the configuration of the particular system can also be obtained by legal means.

The components of the system are proprietary and thus their function is not common knowledge but information can be obtained legally by purchasing the Programmer's Manual which contains every detail regarding the system, be it functions or configuration.

Some systems, especially old Arcade cabinets, use generic components widely available in the market. Since of course those components are not proprietary, i.e. custom made, it is to the best interest of the manufacturer to make the specifications of their products available⁸⁴, in order to promote their sales. The behaviour of those components will then depend upon their configuration on the board, the analysis of which is provided by the schematics. Most of the old Arcade cabinets were supplied with such Service Manuals. Having knowledge of both function and configuration is all the information a programmer needs. Similar is the situation with proprietary components, more common in Game consoles, but for one difference. A custom-made chip, as the word defines it, is manufactured for a specific purpose and thus it is not to the best interest of a company to make this information available to the public, since it is not for sale. In some instances however, such information have been made available as in the case of the Atari 2600 console and a cartridge called "Magicard", which allowed one to program the 2600. The Magicard came with an extensive programming manual for the 2600 console, which proves to be useful also with the Atari 5200 console due to the similarities between the two systems⁸⁵. There is however a legal implication to address here, as I foreclosed earlier.

Under Article [6\(1\)\(b\)](#), decompilation is allowed as long as "the information necessary to achieve interoperability has not previously been readily available" to the

⁸⁴ For example, the Z80 documentation is available @ <http://www.zilog.com/support/sd.html>. One can also argue that by being generic, the merger doctrine may apply.

⁸⁵ I would like to thank Dan Boris for bringing the Magicard "affair" to my attention.

programmer. This means that copyright holders can effectively remove the right to decompile by making the information available, and may also be entitled to charge for providing this information even when disclosure is mandatory⁸⁶. Having seen the provisions of Article 6(1)(b), one understands that there is a clash between the Article and programmers' practices, the Article's provisions of course prevailing. For a programmer to decompile for his sheer convenience when the appropriate information is or has been made available to him, constitutes a copyright infringement and so does the resulting program, i.e. the Emulator. The position is less clear when decompilation is conducted under those circumstances but in order to clarify matters which are not clear in the documentation. Common sense dictates that decompilation in order to clarify vague information is permissible, but the most orthodox view would perhaps be to do so after attempts to clarify the point with the company issuing the information have failed. Since Article 1 protects also "preparatory design materials", the abovementioned documentation being such, the "rules" of Emulation remain the same regardless of the technique used.

Having elaborated on how Emulators are written and the legal issues rising in relation to these programs, we shall now investigate two recent US jurisdiction cases where Emulators as such is the subject of litigation.

⁸⁶ For the benefit of competition, a court may oblige one to release such information. See Downing, *op. cit.*, para. 4.38 p. 90.

Chapter IV: Emulators in the Court of Law

The legality of Emulators was recently challenged in the US courts twice, when Sony brought actions against both commercial Playstation Emulators, [Bleem!](#) and [VGS](#). Although they are of limited perhaps interest since they are both tried in US jurisdiction and the actual trials are pending, it is worth looking at the legal issues raised in motions for preliminary injunctions. At first instance and on appeal Sony focused upon two elements; copyright and trademark. We shall proceed accordingly.

In [Sony v Connectix](#)⁸⁷, the subject for consideration was not whether Connectix's Emulator contained any infringing element of the Papillon code; Sony admitted that it did not. Instead, the first thing that Sony alleged was the infringing disassembly of the Playstation BIOS and that the repeated intermediary copies that were created by copying the BIOS Image into RAM were infringing copies. Primarily based on these grounds, the judge issued a preliminary injunction against Connectix; his points were reversed on appeal⁸⁸. The Court of Appeals found the disassembly of the BIOS necessary in order for Connectix to understand how the Playstation works, i.e. examine the underlying concepts of it not protected by copyright, citing the case of *Sega v Accolade*⁸⁹. Bearing in mind the analysis given previously on Article 6 of the Software Directive and its relation with the cited case, it is obvious that a European court would have reached the same conclusion⁹⁰. Similar would probably be the outcome regarding the repetitive intermediate copying of the BIOS to RAM by reason of Article 5(1). Weight, should not been given to the "repetitive" copying, as Sony suggested, since it is incidental; as the Court argued, it could have been avoided by not switching off the computer. At first instance, Sony alleged that the reverse engineering of the custom-made chips Geometry Transfer Engine (GTE) and Graphics Processing Unit (GPU) was wrong because it considers

⁸⁷ [Sony Corporation of America v Connectix Corp.](#), 48 F. Supp. 2d 1212, 1216 (N.D. Cal. 1999).

⁸⁸ [Sony Corporation of America v Connectix Corp.](#), 203 F. 3d 596 (9th Cir. 2000). By reading the appeal reasoning one will probably conclude that the judge who issued the injunction has seriously erred in his decision.

⁸⁹ See Note 72.

⁹⁰ A further argument on the similarity between the two notions is provided by England which permitted decompilation for studying purposes under the similar "fair dealing" provision prior to the Directive. It has now substituted that right, by excluding it from the fair dealing provisions of s. 29(4) CDPA 1988, in order to reinstate in s. 50B which implemented Article 6 of the Software Directive.

the processes performed “trade secrets”. This consideration would probably fail in a European court by reason of Article 82 of the Treaty of Amsterdam. Given the fact that the Emulators in question are commercial products, Sony could be seen as abusing its dominant power and seeking to establish a monopoly on the Playstation software. A court would therefore consider to oblige Sony to provide the needed information following the settlement in *IBM v Commission*⁹¹, if such petition has been made prior to the filing of the case, or disregard it upon evidence, as in Connectix’s instance, that attempts were made to obtain the information by agreement.⁹² On the relevant subject, the US Court of Appeals stated that “if Sony wishes to obtain a lawful monopoly on the functional concept of its software, it must satisfy the more stringent standards of patent laws”⁹³. Four days after the trial, Sony filed a separate lawsuit alleging the infringement of eleven audiovisual patents, only to voluntarily dismiss it one day before it actually went on trial and simultaneously file an amended one. Sony has not made any information regarding the patent lawsuit available.

The other issue raised at first instance was that of trademark, in relation to use and tarnishment. Both claims were rejected by the Court of Appeals, primarily for two reasons. The court stated that since the operation of a computer program is by definition dependent upon compatibility with a given platform, Connectix had the right to advertise as “A Playstation Emulator”, “Capable of playing Playstation games”. This reasoning is so profoundly correct that a legal analysis is not needed⁹⁴. Tarnishment was raised by Sony in the context that Playstation might be associated with an, admittedly, inferior product. The court of Appeal reversed that decision due to lack of evidence, by reasoning that the bad performance of some games with the [VGS](#) was not misattributed to the games or the Playstation but rather to the Emulator itself. The idea that a game not performing well on an Emulator, which explicitly stresses on its package that absolute compatibility with all games is not guaranteed, can be misunderstood by a user as inferior quality of the game it self is remote⁹⁵. The only remaining issues now pending for trial, after the dismissal of the rest by a

⁹¹ (Case 60/81) [1981] ECR 2639.

⁹² Note also that according to the English case of *Mars (UK) v Teknowledge* (unreported) High Court, Chancery Division, June 11, 1999, Connectix would not own a right of confidentiality to Sony.

⁹³ [Sony Corporation of America v. Connectix Corp., 203 F. 3d 596 \(9th Cir. 2000\)](#) at 1717.

⁹⁴ In England, for example, the equivalent exception is found under s.11 of Trade Marks Act 1994.

⁹⁵ cf. with the English case *Taittinger SA v Allbev Ltd* [1993] FSR 641, but note that it is considered unique and has been criticized

summary judgment, are those of trade secret and unfair competition which will be eventually tried probably in September 2000.⁹⁶

Similar were the charges in *Sony v Bleem*⁹⁷ but a restraining order was not granted because on a balance of probabilities the judge did not find that Sony will be justified. A catalytic reason was that *Bleem!* was not based on decompilation. Sony did not detest that. “In developing its Emulator, Bleem treated the PlayStation as a black box, simply reproducing what the machine does in response to a given instruction in a game's program code. If instruction A puts a red dot on the screen, then all Bleem! has to do is put a red dot on the screen whenever it encounters instruction A--how it does that is irrelevant”⁹⁸. In legal terms, is it “clean room” reverse engineering and therefore unlike that the position would be different in Europe. The question on appeal was not the legality of the Emulator but rather whether Bleem had the right to present pictures of a Playstation game running on Bleem! at the back of the software's package. By reasoning that due to the nature of the product Bleem had to necessarily relay upon images from Playstation games, and by also adding that it was a de minimis infringement, for “a frame constitutes 1/30th of a second's worth of a Videogame”⁹⁹, the court rejected the claim of copyright infringement; same would have been the result in England, for example, under the fair dealing principle¹⁰⁰. Bleem has now brought an action against Sony, claiming among others that Sony has unlawfully acquired, maintained, and extended its monopoly in the video game market through a combination of anticompetitive practices, in addition to restraint of trade, and defamation¹⁰¹.

⁹⁶ Connectix has assisted the author in many occasions but declined to comment on the trial facts by reasoning that they cannot comment on the litigation “while the suit is in progress”. This is completely understood

⁹⁷ [Sony Corporation of America v Bleem, LLC, \(unreported\) D.C. No CV-01590-CAL](#)

⁹⁸ Tony Smith, “The Connectix Case far from Settled”, MacWeek.com 21 February 2000, <http://macweek.zdnet.com/2000/02/20/0221mwregister.html>. Although it is known to the author that the Playstation BIOS was not decompiled or used by Bleem LLC in connection with Bleem!, he cannot comment further on the technical merits of this type of emulation programming, for *Bleem!* and KGen, a Sega Genesis/Megadrive Emulator by Steve Snake, are the only Emulators to take this approach to the best of his knowledge. Thus, there are not sufficient information in order for him to understand or explain the process and techniques involved on this particular type of emulation. It is worth noting that Bleem has not responded to the authors inquires.

⁹⁹ [Sony Corporation of America v. Bleem, LLC \(unreported\) No. 99-17137 \(9th Cir, 2000\), 10 July 2000](#) at 7656

¹⁰⁰ See General Note under s. 29 CDPA 1988

¹⁰¹ Bleem LLC Press Release @ <http://www.bleem.com/about/files/12-13-99/b!antitrust.pdf>

As the judge consented in [*Sony v Connectix*](#), the effect that those Emulators might have for Sony is to actually boost the PlayStation games sales¹⁰² rather than to hinder them. But for the patent issues, for which little is known, it is unlikely that either Emulator will be found infringing an Intellectual Property Right.

¹⁰² A Playstation console can be currently purchased for as little as £70, initial price £180, while a software title still costs around £30. The profit for the Game Consoles Industry is at software sales, not at hardware sales.

Chapter V: Roms, Emulators the Industry and Some Thoughts*

One could say that Emulators, being essentially the “Operating System” for games, are useless if the appropriate games are not available. This assumption is however incorrect. An Emulator is useful as such, for it is a program that someone has spent much of his time to write, mainly in order to improve and measure his programming abilities. Once an Emulator’s user manages to “ease” the enthusiasm of the first impression when he rediscovers an old favourite game, he soon realizes that he has in his possession an amazingly good program. I, for example, found the most interesting part of Emulators being my effort to comprehend how they work.

Not everybody however shares the same enthusiasm or finds the same interest. “If the sole purpose of an emulator is to allow the playing of a console game on a PC, and the owner of the copyrights in that console game has not authorized the copying, performance, display, or derivative work created when a console game is played on a PC, then the creation and use of that emulator constitutes an infringement of the copyrights in the console game”¹⁰³.

The purpose of writing an Emulator is not to enable one to play a game; it is to reconstruct an old, most of the times, system. In the words of [MAME Team](#) “Even though MAME allows people to enjoy the long-lost Arcade games and even some newer ones, the main purpose of the project is to document the hardware (and software) of the Arcade games. There are already many dead Arcade boards, whose function has been brought to life in MAME. Being able to play the games is just a nice side-effect”. If the motives behind Emulators were not those, programmers would not emulate all titles, some of which can hardly be characterized as “commercially successful”, but simply only the ones of their preference. It would thus seem that Emulators are in line with the Industry’s definition of legality.

* In a paraphrase of Peter Greenaway’s movie “The cook, the thief his wife and her lover”.

¹⁰³ The statement was taken from the Interactive Digital Software Association (I.S.D.A) website, to which most but not all, the reason being Emulators, Videogame manufactures are members @ <http://www.idsa.com/piracy.html>. The above statement seems to equalize Emulators with the technical measures’ circumvention hardware discussed later.

What if one however was to suggest that all Roms are illegal? ¹⁰⁴ Before addressing this question, it is preferable to put forward a more detailed definition of Roms¹⁰⁵. “A Rom is a binary file which can contain graphics, sounds, and program code. For example, the Rom Image of Metroid is all the information contained within the cart. The cart's information is transferred, or "dumped", onto a computer by a person with the skills and resources to do so. You can run them with the appropriate emulator”¹⁰⁶.

If one was to mistakenly relate Emulators' legality with the question of whether they are capable of loading the intended software in its original medium, the assumption that all Emulators are illegal would not be correct because some Emulators, admittedly few, such as [VGS](#), [Bleem!](#) and [NeoGeoCD](#) are using CD-ROMs, i.e. the software in its original form, and not Roms, those CD-ROMs being available for purchase by anybody, owner of the intended system or not¹⁰⁷. Let us disregard this fact though and assume that the software for all Emulators comes in the “medium” of Roms. According to this train of thought, all Roms are the products of software piracy and Emulators are therefore illegal for promoting such acts; this however again is not true. In order to consider whether or not a Rom is an infringing copy, one must first examine whether a copyright holder exists and if so, if this copy is an authorized or an unauthorized one by the copyright holder.

Although admittedly this is not the general rule, some copyright holders, software programmers for the original systems, have given their consent for their programs to be freely distributed in the format of a Rom Image. An example is the 1981 game called “Robby Rotto” by Jay Fenton, originally written for Bally Midway's Arcade cabinets¹⁰⁸. Furthermore, many programmers have written games, referred to as “home-brews”, for exclusive use with Emulators. In theory of course, one could transfer the program to an appropriate medium and use it with the original system but could not sell it as a game endorsed by X for X's system. These “home-

¹⁰⁴ Though I submit this with some reservations, I strongly believe that Nintendo, the company with the most negative opinion about emulation, at an earlier version of their Intellectual Property Protection Section had condemned the existence of all Emulators and Roms @ <http://www.nintendo.com/corp/faqs/legal.html#faq>

¹⁰⁵ The plural of a Rom (Image). To the detriment of the English language, also familiar as “Romz”, similar to “Jimmy'z”, “(be)cuz” and “da man”; the list is endless.

¹⁰⁶ @ <http://www.zophar.net/faq/nitrofaq/faq2.html>

¹⁰⁷ Nintendo in its current [FAQ](#) disregarded this fact because no Nintendo system uses CD-ROMs, yet. It is interesting to see if the statement is going to change should a new console, having as a “slot” a CD tray, is released.

¹⁰⁸ Jay Fenton's statement is available @ <http://www.mame.net/romsrobby.html>

brewed” games also come with a right for free distribution. Finally, one should mention some commercial endorsement which are Emulator-related. [HanaHo Games, Inc.](#), the manufacturer of HotRod “joystick” and Arcade PCs¹⁰⁹, bought the exclusive rights and a licence to distribute with its products a number of Capcom’s games in the medium of Roms¹¹⁰. This action is significant for three reasons. First, HanaHo’s products are essentially depended on the existence of Emulators; without Emulators, few people would perhaps be interested in buying them. This means that HanaHo must approve the existence of Roms for it is to its commercial benefit. Secondly, HanaHo not only approves the existence of Roms but also supplies them with its products. Thirdly, and this is probably the most important point, when Capcom decided to grant those rights to HanaHo, it did so being aware of the abovementioned facts. Thus, one can logically conclude that Capcom, being one of the most respected Arcade manufacturers if not *the* most respected, supports the existence of Roms¹¹¹. Another paradigm from the Videogame industry is Sega which decided to release in the US a game pack called “Sega Smash Pack”. This software from Sega was based on a version of the KGen Emulator and was of course running Roms.

Having mentioned the above, one understands that all Roms are certainly not counterfeit copies and can of course draw the conclusion that not everybody in the Videogame industry is against any of their systems being emulated. The most direct statement has been made by Hasbro regarding the Atari Jaguar console:

“We realize there is a passionate audience of diehard Atari fans who want to keep the Jaguar system alive, and we don't want to prevent them from doing that. We will not interfere with the efforts of software developers to create software for the Jaguar system”.¹¹²

Even if we were to assume that the legality of an Emulator is related to the availability of appropriate software, i.e. by disregarding CD compatibility refer to Roms only, the existence of legally obtainable Roms justifies the existence of

¹⁰⁹ HotRod can be best described as a controller and not a joystick, for it resembles the controllers of Arcade cabinets. An Arcade PC is an Arcade cabinet which is internally power by a computer. In essence, it is a computer looking like and having the User Interface of an Arcade Cabinet. Both products are of course targeted at Emulators users.

¹¹⁰ Statement available @ <http://www.hanaho.com/>

¹¹¹ The fact that this was a conscious act is further reassured by the fact that HanaHo was hosted in Capcom’s booth at the Electronic Entertainment Exposition 2000. The E3expo is the most significant exposition for the Videogame Industry.

¹¹² The full statement is available @ <http://www.digiserve.com/eescape/atari/articles/Hasbro-Releases-Jaguar.html>

Emulators. The fact that Emulators can be also used in conjunction with wrongfully acquired Roms is not sufficient in order to proclaim Emulators illegal. In order for an Emulator to be illegal, it must be proven that the sole purpose of its existence is to run infringing copies of software; not merely being able to also do that. The fact that a “legal” product, such as a knife, can also be used for “illegal” purposes, such as murder, does not render that product illegal. This approach is not only consistent with logic, but is also a judicial precedent in many jurisdictions¹¹³.

The subsequent question that should born into one’s mind is the legal position of Roms of commercially released games for which copyright holders still reserve all their rights, as in the case of all Nintendo titles for example. Does one by dumping a cartridge creates an infringing copy? Should this assumption be correct, and by relating Emulators’ legal status with that of Roms’, it could effectively be argued that an Emulator of that particular system is promoting the creation of infringing copies and is thus illegal. In order to answer that question, one has first to determine the nature of the product. A circuitry board, be it in the medium of cartridge or not, can be potentially classed under two titles; it can be deemed to be “software” in its conventional meaning, for ultimately it contains instructions, or it can be seen simply as a semiconductor product. There is a difference in law between the two definitions and we shall address both instances, starting from assuming that it is software¹¹⁴.

The Software Directive, as we have previously discussed, covers all programs regardless of the medium that they reside into. One can thus make the assumption that cartridges, for example, are included within the definition of a program. According to Article [5\(2\)](#) of the Software Directive, “the making of a back-up copy by a person having a right to use the computer program may not be prevented by contract insofar as it is necessary for that use”. It is common knowledge that everything in life, including the mediums that software come into, is susceptible to

¹¹³ E.g. the English cases of *Amstrad Consumer Electronics plc v The British Phonographic Industry Ltd* [1986] FSR 159 and *CBS Songs Ltd v Amstrad Consumer Electronics plc* [1988] WLR 1191 regarding the twin-tape cassette machine and the US case of *Sony Corporation v Universal City Studios* (1984) 78 L. Ed. 2d 574, regarding the BetaMax video recording system. At all three cases, the issue was that the product could be used for the creation of counterfeit copies. It also has to be mentioned here, in relation to the .mp3 format parallelism made in earlier, that the pledge of the music industry for the .mp3 format to be abandoned was not satisfied because the computer industry considers it a valuable “tool” for compressing audio files.

¹¹⁴ Note that Nintendo is [characterising](#) its cartridges as semiconductors, but apparently bases that on US judicial decisions. The author has been unable to find similar decisions within Europe. Note also that Nintendo has responded to the author’s preliminary inquires stating that they would be forwarded to their Legal Department but at a time period of five months no reply has been received.

destruction either by accident or by “tear and wear”. One can thus effectively argue that backup copies are always “necessary”. Many companies acknowledging this fact have included such right in their licence agreement¹¹⁵. An innuendo rises regarding the instances where companies offer to substitute the damaged product with a new one. One could say that a company by doing so, removes in effect the right to backup a software since it may no longer be deemed to be “necessary”; this however is not clear by the Directive¹¹⁶. In reality, most game software comes with a “90-Day Limited Guaranty”, be it a PC game in CD or a cartridge for GameBoy, under which the company offers to replace the damaged product usually, but not always, free of any charge. After the lapse of this period, damaged copies are either substituted at a considerable amount¹¹⁷ or not substituted at all. This limited time period of availability for substitution of the damaged product directly from the copyright holder suggests that the backup “right” cannot be defeated by the 90 days warranty. Bearing in mind that the Directive covers programs in any form, this should also extend to create a backup in any form. Few would disagree that in the absence of a CD-Recorder one still has the right to backup a program in Floppy Disks, despite how time consuming this might be. If we were to disregard that the Directive covers programs in any form, we would then face a problem in relation to “circuitry-based” software, this being the dominant medium for Videogame systems’ software. According to this train of thought, the change of storage medium, necessary since to create a duplicate of a circuitry is not something possible apart for industrial units, would amount to the resulting copies being characterized as infringing. The counter argument of course is that the transition of a cartridge’s, for example, instructions to a ROM Image should not be viewed as an “adaptation, translation, arrangement or other alteration”, since the person making the copy does not deny that this is a copy of the rightholder’s program, but rather as a technical necessity for backup purposes¹¹⁸. After all, the right to backup does not come with any restraining provisos. In support of this argument, reference can be drawn here to the practises concerning blind

¹¹⁵ E.g. See clause 6 of Windows 98 licence agreement.

¹¹⁶ Nor has it been raised as an issue. See para. VII.2. of the [Commission’s Report](#), op. cit.

¹¹⁷ E.g. Diablo II of Blizzard Entertainment is comprised by three CD-ROMs. The initial marketing price of the game is £29.99 while substitution after the 90 days period costs £6 per disk, meaning a total of £18 in the worst possible scenario. One year after its release, the marketing price of the software will be around £20.00.

¹¹⁸ Pettus suggests that in the US this claim would fail. See Pettus, S., “EmuFAQ” <http://www.overclocked.org/emufaq/EmuFAQ.pdf>, p.82.

people¹¹⁹. It is acknowledged as a technical necessity that books must be “translated” to Braille in order for blind people to be able to read them. If we were to take a strict approach, this translation would constitute a copyright infringement since the Braille edition of the book is in effect an unauthorized change of medium within which the exact same text is contained. This however would in effect deprive the proper use of the book from a person who has lawfully acquired that book¹²⁰. It therefore seems logic, even if we were to interpret the Directive in that manner, for the law to accommodate “exceptions” where needed, in order to maintain the rights that it confers.

On the other hand, circuitry-based software can be characterized by the medium that it comes into, i.e. as a semiconductor¹²¹. In this case, the appropriate Directive to look at would be the Semiconductors Directive¹²² and one should address this instance, for Software Directive’s provisions are “without prejudice to any other legal provisions such as those concerning patent rights, trade marks, unfair competition, trade secrets, protection of semi-conductor products or the law of contract”¹²³. Although going into deep analysis of the Semiconductors Directive does not serve our purposes, the following points should be mentioned. The purpose of the Directive is not so much to protect the unauthorized copying of a semiconductor but to insure that only the proprietor can benefit, in the commercial sense, from it. Hence, Article 5(2) states that “a Member State may permit the reproduction of a topography privately for non commercial aims”. Most Member States have permitted such action¹²⁴. Reproduction thus for private non commercial aims, backup being such, is therefore permitted. In any event, the instructions contained in the circuitry, i.e. the game, would probably not be covered by the Semiconductors Directive since, protection is not extended to “any concept, process, system, technique, or encoded information embodied in the topography”¹²⁵. Same would probably be the conclusion if we were to consider the emulated parts of a videogame system as semiconductors,

¹¹⁹ Paraphrasing Vinje’s paradigm regarding technical measures’ circumvention. See Vinje, T. “Copyright Imperilled?”, (1999) 4 E.I.P.R., p.192.

¹²⁰ With relation to disabilities, explicit provisions granting such rights apply.

¹²¹ Assuming that the medium is a semiconductor. Many circuitry components are in fact not, due to inadequate mask layers. See Bainbridge, op. cit, p. 143.

¹²² Council Directive 87/54/EEC on the Legal Protection of Topographies of Semiconductors Products, OJ 1987 L24/36.

¹²³ Article [9\(1\)](#)

¹²⁴ Eg. England. See s. 226(1A) CDPA 1988.

¹²⁵ Article 8.

not only by reason of the abovementioned Articles, but also due to consideration of the right to reproduce a semiconductor for the purpose of “analysing, evaluating or teaching”¹²⁶, as well as create a new one based on reverse engineering¹²⁷. It is therefore highly unlikely that any aspect of Emulators, be it at a programming level or at a “software” level, will be deemed as infringing under the Semiconductors Directive.

A final matter for consideration regarding the legal status of Emulators and the software that they use, be it in the form of a ROM Image or not, is related to technical measures taken by the industry in order to prevent “access” to its products¹²⁸. With the digital and network revolutions, copyright infringements have become more frequent and their effects have impact at a greater scale. For example, it takes one to upload a program to the Internet in order for the whole world (literally) to acquire it, without paying any money to the beneficiary whatsoever. In response to this legitimate, and other not so legitimate, considerations many programs are now protected with various techniques. With regards to our immediate interest, the technical measures concerning us are those of data encryption and copy protection. The problem with those technical measures is that they aim at restricting access to a program’s core and copying it. These might be legitimate measures in order to prevent derivative works and infringing copies from being created, but at the same time forbid one from exercising his rights, i.e. decompilation and backup. In other words, they confer copyright protection to elements that are explicitly not protected. As of course any poison has its antidote, any protective measure has a circumventing measure. So, now the question is not if such protection is legal¹²⁹ but rather if circumvention is illegal. In the context of Emulators this point is crucial, for all the modern videogame systems and their software are somehow protected¹³⁰. The circumvention of protective measures is conducted through appropriate software, hardware or a combination of both. Addressing this exact point, Article [7\(1\)\(c\)](#) of the

¹²⁶ Article 5(3). As we mentioned earlier, only few Emulators are released commercially and most are written for studying and evaluating purposes.

¹²⁷ Article 5(5). This provision obviously covers the commercially released Emulators.

¹²⁸ For an extensive discussion on this subject, see Marks, D. and Turnbull, B., “Technical Protection Measures: The Intersection of Technology, Law and Commercial Licences”, (2000) 5 E.I.P.R., p. 198

¹²⁹ Although one could argue that such protective measures are in fact illegal. See generally Vinje, T. “Copyright Imperilled?”, (1999) 4 E.I.P.R., p.192 cf. Article 6(1) of the [Amended Proposal for a European Parliament and Council Directive on the Harmonisation of Certain Aspects of Copyright and Related Rights in the Information Society COM\(1999\) 250 final 21 May 1999](#), p.23.

¹³⁰ Most notably the CPS2 system, which encryption is considered a masterpiece and therefore not emulated, yet.

Software Directive penalizes “any act of putting into circulation, or the possession for commercial purposes of, any means the sole intended purpose of which is to facilitate the unauthorized removal or circumvention of any technical device which may have been applied to protect a computer program”. This however is provided, according to Article 7 “without prejudice to the provisions of Articles 4, 5 and 6”. Circumvention is thus permitted for the purposes of decompiling, reverse engineering and creating backups. This provision is also important for it probably also permits the sale of “dumpers” under the *Amstrad v BPI*¹³¹ reasoning. Interestingly, Sony in both litigations concerning Emulators, put forward as a claim that the [VGS](#) and [Bleem!](#) are facilitating software piracy because they do not include a mechanism found in the Playstation which does not allow one to run a copied game; this claim of course failed. It is worth noting here that the US has taken a strict approach regarding circumvention, focused mainly on banning devices that facilitate circumvention rather than the act, and that the Commission in a proposal has somewhat followed, although in a milder manner¹³². This however seems to be a bit controversial, bearing in mind that those who press for such legislation are also those who produce CD-Recorders, blank media etc.

Having mentioned the above, it should be well understood that those legal facts and speculations apply with reference to legal owners of licensed programs only, creating their own backups. Though it is legal for anyone to own an Emulator, it is not legal for everyone to acquire a ROM Image. If however one is to search the Internet, he will find a plethora of ROMs to download. Although I will not try to tackle the question of Internet Service Provider liability and the question of Internet in general, I would like to put forward the following, perhaps radical, views for the reader’s consideration.

It is well stated in all software licences that by purchasing a software one does not become the legal owner of a program; he is merely licensed to use it. Following the reasoning of licensing, it can be said that one does not acquire the right to use something tangible, i.e. a particular CD-ROM, cartridge or whatever, but the right to use the program in general. It can thus be argued that by downloading the dumped

¹³¹ *Amstrad Consumer Electronics plc v The British Phonographic Industry Ltd* [1986] FSR 159. In relation to the previously raised issue, regarding the right to back up despite the potential change of medium, one could also add that the inapproachable medium of circuitry acts as a protective measure which can be circumvented in order to facilitate the creation of a backup.

¹³² For an extensive analysis, see Vinje, T. “Copyright Imperilled?”, (1999) 4 E.I.P.R., p.192 at p. 201

ROM Image of another's cartridge one does not acquire a backup that he is not entitled to have, provided of course that he is indeed a licensed user, since he is acquiring the program that he has acquired a licence for. Although this theory could fail on the grounds of "one" backup copy¹³³, the counterclaim is that every licensed user acquires "one" backup. Assuming that this does not stand, a further question would be if a person has the right to upload material to the Internet that may potentially be downloaded by unlicensed people. Since new computers such as Macintosh i-Macs do not come with a floppy drive, the suggestion being that the natural form of backup nowadays is that of uploading to the Internet¹³⁴, one could argue, in a parallelism with the Amstrad precedent, that it is not the "uploader's" fault that someone may download data not entitled to. This allegation could stand in Europe but not in the US, since Internet there has been deemed to be a "public forum"¹³⁵. What about FTP¹³⁶ sites, especially when the actual FTP server is one's Hard Disk? An FTP cannot be characterized as a commercial forum because access to it is conditional and it is essentially a designated invitation to one's house.

Given the enormous illegal exploitation that such an approach would have, it is highly probable that a court would find against such suggestions. Still, if we were to disregard the policy considerations, one has to admit that in principle those speculations have a legal basis.

¹³³ See para. VII.2 of the [Commission's Report](#), op. cit.

¹³⁴ As a matter of fact, e-mailing has been used for backing up the progress of this dissertation.

¹³⁵ See Pettus, S., "EmuFAQ" <http://www.overclocked.org/emufaq/EmuFAQ.pdf>, p. 100.

¹³⁶ File Transfer Protocol.

Trip and Fall: Instead of an Epilog

Having passed all tests with “flying colours”, it is somewhat tragic that many Emulators might actually end up being characterized as “infringing” at the very end.

The problem with [MAME](#) and other “retro-gaming” Emulators, such as [RockNES](#) is that they are relying, either partially or entirely, on “code” created prior to January 1st, 1993. This fact would be of no importance to agreements, i.e. purchase of systems, concluded after January 1st 1993, irrespectively of date of creation¹³⁷, but would be relevant to agreements concluded prior to that date, since under Article [9\(2\)](#) of the Software Directive, the provisions of the Directive apply “without prejudice to any acts and rights acquired before that date”. On a balance of probabilities, I would say that the strong presumption is for most systems to have been acquired prior to that date. The Semiconductors Directive, if it is indeed relevant, makes similar provisions under Article 10(3) for the 7th of November 1987. Although this renders void what we have discussed at a large extend, it does not necessarily mean that prior national legislation did not address the question at all, or at least to some extend. The English concept of “fair dealing” for example would cover some instances. A potential fall, mainly, but not exclusively, for the so called “Next-Gen” Emulators such as [VGS](#) and [UltraHLE](#), is that they might be taken as unreasonably prejudicing the right holder's legitimate interests or conflicting with the normal exploitation of their systems, or even games in the case of [UltraHLE](#) which uses Roms only. In this respect, Nintendo can be said to be in the worst position within the industry. This, under Article [6\(3\)](#) of the Software Directive would render the decompilation right void. The US courts’ approach to ascertain the right of decompilation in the context of fair use is interesting in this respect. Though according to law if one’s rights are infringed this is to be deemed regardless of potential commercial significance, those who have gone to the court or have seriously threaten to do so are in fact only the proprietors of videogame consoles which are still viable products, despite the fact that the Emulators in question are not as good as to substitute the original consoles. This does not mean that other companies’ rights might not be infringed but for Capcom to go to the courts, being an

¹³⁷ Article [9\(2\)](#) of the Software Directive prescribes that “The provisions of this Directive also apply to programs created before 1 January 1993”. This applies also to backups.

Arcades' manufacturer, would primarily be a matter of principle, not loss of profits. On the other hand, Emulators have revived the interest for retro-gaming and created the interest for videogame titles to be used with computers so companies might finally decide to officially endorse Emulators and of course benefit from selling "smash packs"¹³⁸; traditional non-PC software producers have been thrown into the PC market and they did not even have to advertise. Or of course they could retain the current status quo of "hear no evil, see no devil".

Perhaps companies would prefer for none of their systems to have been emulated. Perhaps everything I stated here and all legal analysis I have made is wrong. The facts however remains the same; since Emulators exist, Roms are dumped and Internet cannot be effectively regulated, and it will not be regulated so by any proposed legislation I have come across to, emulation will go on. Although one cannot suggest that one's inability to ascertain his rights automatically renders them void, one should take a look at situations under the prism of reality and practicability. Capcom, Sega and Hasbro have been congratulated many times for their relaxed stance towards emulation, and these congratulations come mainly from their old customers. On terms of Public Relations, a very important commercial concern, they have gained a lot. Nintendo on the other hand, being a fierce objector of Emulators, has not gained much; its consoles are still emulated and its cartridges are dumped. The only difference is that their old customers look at them with a grin.

There is a Greek saying for that, rude to reproduce here, but the notion remains the same; if you cannot avoid something, enjoy it.

¹³⁸ See [Appendix IV](#)

Table of Cases

Amstrad Consumer Electronics plc v The British Phonographic Industry Ltd [1986] FSR 159

CBS Songs Ltd v Amstrad Consumer Electronics plc [1988] WLR 1191

Cantor Fitzgerald v Tradition [2000] RPC 95

Electronic Techniques (Anglia) Ltd v Critchley Components Ltd [1997] FSR 401

IBCOS Computers Ltd v Barclays Highland Mercantile Finance Ltd [1994] FSR 275

IBM v Commission (Case 60/81) [1981] ECR 2639

John Richardson Computers Ltd v Flanders [1993] FSR 497

Mars (UK) v Teknowledge (unreported) High Court, Chancery Division, June 11, 1999

Microsense Systems Ltd v Control Systems Technology Ltd (unreported) 30 March 1994

NEC Corp v Intel (1989) 10 USPQ 2d

Sega Enterprises, Ltd. v. Accolade, Inc 977 F.2d 1510 (9th Circ., 1992)

Sony Corporation of America v Bleem, LLC, (unreported) D.C. No CV-01590-CAL

Sony Corporation of America v. Bleem, LLC (unreported) No. 99-17137 (9th Cir, 2000), 10 July 2000

Sony Corporation of America v Connectix Corp., 48 F. Supp. 2d 1212, 1216 (N.D. Cal. 1999)

Sony Corporation of America v Connectix Corp., 203 F. 3d 596 (9th Cir. 2000)

Sony Corporation v Universal City Studios (1984) 78 L. Ed. 2d 574

Sudwestdeutsche Inkasse KG v Bappert und Burker Computer GmbH (1985) Case 5483, BGHZ94, 276

Taittinger SA v Allbev Ltd [1993] FSR 641

Bibliography

Textbooks

Bainbridge, D., "Introduction to Computer Law", 4th Edition, Longman, 2000

Downing, R., "Information Technology Law", John Willey & Sons, 1995

European Legislation

Council Directive 87/54/EEC on the Legal Protection of Topographies of Semiconductors Products, OJ 1987 L24/36

Council Directive 91/250/EEC on the Legal Protection of Computer Programs, OJ 1991 L122/42.

Also available @ http://europa.eu.int/eur-lex/en/lif/dat/1991/en_391L0250.html

Council Directive 92/100 on the Rental Right and Lending Right and Certain Rights Relating to Copyright in the Field of Intellectual Property, OJ [1992] L346/61

Report from the Commission to the Council, the European Parliament and the Economic and Social Committee on the Implementation and Effects Of Directive 91/250/EEC on the Legal Protection of Computer Programs, COM(2000) 199 final 10 April 2000. Also available @

http://www.europa.eu.int/eur-lex/en/com/pdf/2000/com2000_0199en01.pdf

Green Paper on Copyright and the Challenge of Technology, COM(88) 172 of 7 June 1988. Also available @

http://europa.eu.int/comm/internal_market/en/intprop/indprop/lvconen.pdf

Amended Proposal for a European Parliament and Council Directive on the Harmonisation of Certain Aspects of Copyright and Related Rights in the Information Society COM(1999) 250 final 21 May 1999. Also available @

http://europa.eu.int/comm/internal_market/en/intprop/intprop/news/copy2en.pdf

UK Legislation

Copyright, Designs and Patent Act 1988

Trade Marks Act 1994

Copyright (Computer Program) Regulations 1992 (SI 1992/3233)

Copyright and Related Rights Regulations (SI 1996/2967)

Civil Procedures Rules 26 April 1999

International Legislation

Berne Convention for the Protection of Literary and Artistic Works, 1971

Also available @ <http://www.law.cornell.edu/treaties/berne/overview.html>

World Intellectual Property Organisation (WIPO) Copyright Treaty 1996

Also available @ http://www.wipo.int/eng/diplconf/distrib/96dc.htm - aI_4

GATT Uruguay Round Agreement on Trade Related Aspects of Intellectual Property Rights 1994

Journals

Aplin, T., "Not in our Galaxy: Why "Film" Won't Rescue Multimedia", (1999) 12 E.I.P.R., p.633

Bainbridge, D., "Reverse Analysis and Confidentiality of Software", (1999) Computer Vol. 15 no. 5 Law and Security Report, p.328

Dixon, A. N. and Hansen, M. F., "The Berne Convention Enters the Digital Age", (1996) 11 E.I.P.R., p. 604

Gordon, S., E, "The Very Ideal: Why Copyright Law is an Inappropriate Way to Protect Computer Programs", (1998) 1 E.I.P.R., p. 10

Greaves, R., "The Herchel Smith Lecture 1998: Article 86 of the E.C. Treaty and Intellectual Property Rights", (1998) 10 E.I.P.R., p. 379

Heide, T., "The Berne Three-Step Test and the Proposed Copyright Directive", (1999) 3 E.I.P.R., p. 109

Köhler, C., Burmeister, K., "Copyright Liability on the Internet Today in Europe (Germany, France, Italy and the E.U.)", (1999) 10 E.I.P.R., p. 485

Kroker, E. R., "The Computer Directive and the Balance of Rights", (1997) 5 E.I.P.R. p. 247

Lai, S., "Recent Developments in Copyright Protection and Software Reverse Engineering in Singapore – A Triumph for the Ultra-protectionists?", 1989 5 E.I.P.R.

Sir Anthony Mason, "Development in the Law of Copyright and Public Access to Information", (1997) 11 E.I.P.R., p. 636

Turnbull, B., "Technical Protection Measures: The Intersection of Technology, Law and Commercial Licences", (2000) 5 E.I.P.R., p. 198

Vinje, T. "Copyright Imperilled?", (1999) 4 E.I.P.R., p.192

Case Reports and Briefs

Court Service, High Court of Justice, Chancery Division, Judgement on Cantor Fitzgerald v Tradition [2000] RPC 95, April 15 1999

[http://wood.ccta.gov.uk/courtser/judgements.nsf/8a6242113a3c89f080256642001252c8/5f1f8e04388d39578025688f00551709/\\$FILE/cantor_240200.htm](http://wood.ccta.gov.uk/courtser/judgements.nsf/8a6242113a3c89f080256642001252c8/5f1f8e04388d39578025688f00551709/$FILE/cantor_240200.htm)

News Section: National Reports, UK, Copyright-Reverse Engineering and Encryptions, Mars (UK) v Teknowledge (unreported) High Court, Chancery Division, June 11, 1999, (1999) 9 E.I.P.R., p. N-158

Office of the Circuit Executive, U.S. District Court for the Northern District Of California. Order on Sony Corporation of America v. Connectix Corporation, Case Number C-99-0390-CAL, 20 April 1999

<http://www.ublaw.buffalo.edu/fas/reis/cyberlaw/materials/copyrightcases/connectix.htm>

Office of the Circuit Executive, U.S. Court of Appeals for the Ninth Circuit Opinion on Sony Corporation of America v. Connectix Corporation, Case Number 99-15852, 10 February 2000

<http://www.ce9.uscourts.gov/web/newopinions.nsf/f606ac175e010d64882566eb00658118/06d1e0893fdee11688256881006296b8?OpenDocument&Highlight=2,sony,connectix>

Office of the Circuit Executive, U.S. Court of Appeals for the Ninth Circuit Opinion on Sony Corporation of America v Bleem, LLC, Case Number 99-17137, 4 May 2000

<http://www.ce9.uscourts.gov/web/newopinions.nsf/f606ac175e010d64882566eb00658118/94f8b1188593dbb2882568d5005e53fc?OpenDocument&Highlight=2,sony,bleem>

Office of the Circuit Executive, U.S. Court of Appeals for the Ninth Circuit Opinion on Sony Corporation of America v Bleem, LLC, Case Number 99-17137, 10 July 2000

<http://www.ce9.uscourts.gov/web/newopinions.nsf/f606ac175e010d64882566eb00658118/b915198fd7b6f19488256918005fa17a?OpenDocument&Highlight=2,sony,bleem>

Reports and Press Releases in the World Wide Web

Bleem LLC Press Release, <http://www.bleem.com/about/files/12-13-99/b!antitrust.pdf>

Bloomberg News, “Sony files new suit against Connectix”, CnetNews.com, February 16, 2000,

<http://news.cnet.com/news/0-1006-200-1550993.html?tag=st.ne.1002.srchres.ni>

Connectix Corporation Press Release, June 29, 2000,

http://www.connectix.com/company/press_cvgs_jun2900.html

Connectix Corporation Press Release, May 16, 2000,
http://www.connectix.com/company/press_cvgs_may1600.html

Ian Fried, "Connectix scores partial legal victory against Sony", CnetNews.com, May 16, 2000,
<http://news.cnet.com/news/0-1006-200-1885938.html?tag=st.ne.ni.rnbot.rn.ni>

IDSA Piracy Statement, <http://www.idsa.com/piracy.html>

Nintendo Corporation of America, Inc., Intellectual Property Protection Section
<http://www.nintendo.com/corp/faqs/legal.html#faq>

Robert Brownstone, "Ninth Circuit Clarifies Scope of Fair Use of Computer Code", Fenwick and West LLP, Intellectual Property Bulletin, Spring 2000,
http://www.fenwick.com/pub/ip_pubs/Untitled/untitled1.htm

Tony Smith, "The Connectix Case far from Settled", MacWeek.com, 21 February 2000, <http://macweek.zdnet.com/2000/02/20/0221mwregister.html>.

Videogame Emulation News Websites

Arcade At Home, <http://www.arcadeathome.com/>
Arcade Heaven, <http://www.arcadeheaven.com/>
Classic Gaming, <http://www.classicgaming.com/>
Emulators Unlimited, <http://www.emuunlim.com/>
JoseQ's Emuviews, <http://www.emuviews.com/>
OverClocked, <http://www.overclocked.org/>
The Vintage Gaming Network, <http://www.vintagegaming.com/>
Zophar's Domain, <http://www.zophar.net/>

Videogame Emulators Home Pages

Bleem!, @ <http://www.bleem.com/>
CALLUS, @ <http://bloodlust.zophar.net/amaziah.html>
Genecyst, @ <http://bloodlust.zophar.net/amaziah.html>
Impact, @ <http://www.impactemu.com/>
MAME, @ <http://www.mame.net/>
MAME32, @ <http://www.classicgaming.com/mame32qa/>
MAMED, @ <http://digita.mame.net/>
Massage, @ <http://www.enterspace.org/world/>
NeoGeoCD, @ <http://www.illusion-city.com/neo>
NeoRAGE, @ <http://home5.swipnet.se/~w-50884/emulator/rage.htm>
NO\$GMB, @ <http://www.work.de/nocash/>
RAINE, @ <http://www.rainemu.com/>
RockNES, @ <http://rocknes.emuviews.com/>
SNESx, @ <http://www.snes9x.com/>
System 16, @ <http://www.system16.com/>
UltraHLE, @ <http://www.emuunlim.com/UltraHLE>

VGS, @ <http://www.connectix.com/>
Z26, @ <http://www.whimsey.com/z26>

Lexicons

D. N. Stauroopoulos, Oxford Greek-English Learner's Dictionary, 5th Impression, Oxford University Press, 1993

D. N. Stauroopoulos & A. S. Hornby. Oxford English-Greek Learner's Dictionary, 11th Impression, Oxford University Press, 1994

W. Morris, The American Heritage Dictionary of the English Language, 7th Printing, American Heritage Publishing Co. Ltd, 1971

University of Chicago Campus Computer Stores, "A Glossary of Computer Related Terms", available @ <http://www-ccs.uchicago.edu/technotes/misc/Glossary/>

Sunderland University, "Standard Computer - Term Glossary", available @ <http://blake.sunderland.ac.uk/~ta5wpr/computer.htm>

APPENDICES

Appendix I - Game Consoles Related Material

A Typical Console



This particular Console is the Nintendo 64

A Typical Cartridge



This particular cartridge is the Pokémon Yellow Edition, a 1999 title, for Nintendo's GameBoy Colour. Inside the protective case, the board is similar to a cart of Arcade Cabinets'.

Appendix II - Arcade Cabinets Related Material

A Typical Arcade Cabinet



This particular Arcade Cabinet is the original cabinet of Alien Syndrome, a 1987 title by Sega Enterprises Ltd

A Typical Cart

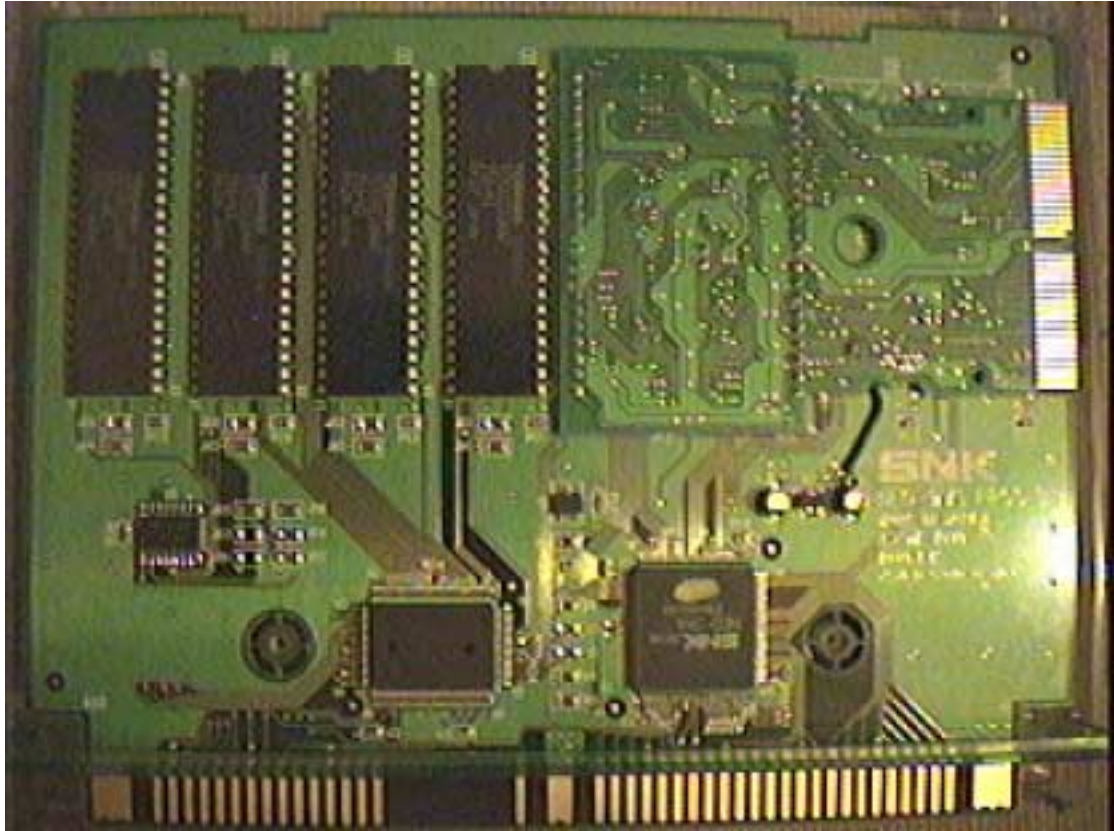

This particular cart, belongs to a NEOGEO Arcade Cabinet

Schematics of a Cart

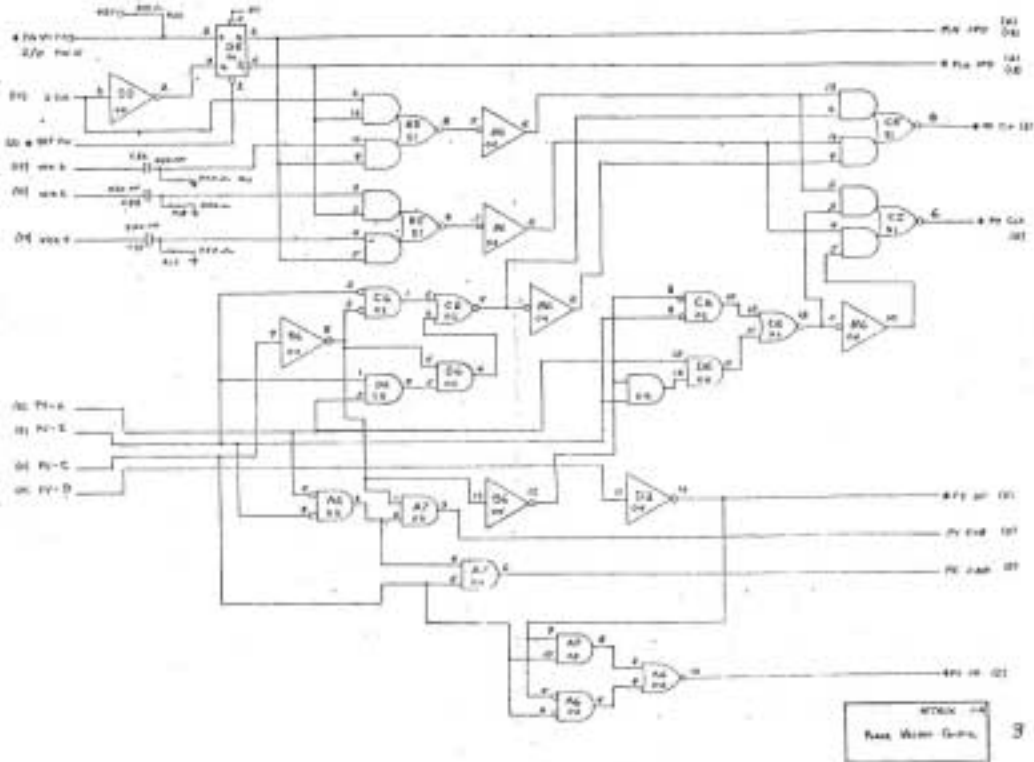

This particular logical diagram belongs to Attack, a 1983 title from Exidy, and it was taken from the original Service Manual

Appendix III - Technical Specifications

Taken from the Videogame Museum @ <http://www.vgmuseum.com/systems/jaguar/>

Atari Jaguar Console Specifications



Processors
(5 in 3 chips):

- "Tom"
- 750,000 transistors, 208 pins
- Graphics Processing Unit (processor #1)
- 32-bit RISC architecture (32/64 processor)
- 64 registers of 32 bits wide
- Has access to all 64 bits of the system bus
- Can read 64 bits of data in one instruction
- Rated at 26.591 MIPS (million instructions per second)
- Runs at 26.591 MHz
- 4K bytes of zero wait-state internal SRAM
- Performs a wide range of high-speed graphic effects
- Programmable
- Object processor (processor #2)
- 64-bit RISC architecture
- 64-bit wide registers
- Programmable processor that can act as a variety of different video architectures, such as a sprite engine, a pixel-mapped display, a character-mapped system, and others.
- Blitter (processor #3)
- 64-bit RISC architecture
- 64-bit wide registers
- Performs high-speed logical operations
- Hardware support for Z-buffering and Gouraud shading

- DRAM memory controller
 - 64 bits
 - Accesses the DRAM directly

 - "Jerry" - 600,000 transistors, 144 pins
 - Digital Signal Processor (processor #4)
 - 32 bits (32-bit registers)
 - Rated at 26.6 MIPS (million instructions per second)
 - Runs at 26.6 MHz
 - Same RISC core as the Graphics Processing Unit
 - Not limited to sound generation
 - 8K bytes of zero wait-state internal SRAM
 - CD-quality sound (16-bit stereo)
 - Number of sound channels limited by software
 - Two DACs (stereo) convert digital data to analog sound signals
 - Full stereo capabilities
 - Wavetable synthesis, FM synthesis, FM Sample synthesis, and AM synthesis
 - A clock control block, incorporating timers, and a UART
 - Joystick control

 - Motorola 68000 (processor #5)
 - Runs at 13.295MHz
 - General purpose control processor
- Bus bandwidth: 106.4 Megabyte per second
- Display:
- Programmable screen resolution. Horizontal resolution is dependent on the amount of scanline buffer space given to the "Tom" graphics processor. Maximum vertical resolution varies according to the refresh rate (NTSC or PAL). Reportedly, a stock Jaguar (without additional memory) running NTSC can display up to 576 rows of pixels.
 - 24-bit "True Color" display with 16,777,216 colors simultaneously (additional 8 bits of supplemental graphics data support possible).
 - Multiple-resolution, multiple-color depth objects (monochrome, 2-bit, 4-bit, 8-bit, 16-bit, 24-bit) can be used simultaneously.
- Colors available: 16.8 million
- Sound: 16-bit
- Ports:
- Cartridge slot/expansion port (32 bits)
 - RF video output
 - Video edge connector: (video/audio output) (supports NTSC and PAL; provides S-Video, Composite, RGB outputs, accessible by optional add-on connector)
 - Two controller ports
 - Digital Signal Processor port (includes high-speed

	synchronous serial input/output)
Dimensions:	9.5" x 10" x 2.5"
Controllers:	Eight-directional joystick Size 6.25" x 5" x 1.6", cord 7 feet Three fire buttons (A, B, C) Pause and Option buttons 12-key keypad (accepts game-specific overlays)
Input/Output:	Cartridge and expansion port, an edge connector User port, also an edge connector 2 x Joystick ports for digital Atari-style joysticks TV output (RF modulator, also transmits audio to the TV) RGB output, including audio and composite video Serial port for connecting printers and floppy drives Tape recorder port, yet another edge connector. This is for Commodore's specialized tape recorder running at 300 bps.

System Notes/History

Other Jaguar features:

- Support for ComLynx I/O for communications with the Atari Lynx hand-held game system and networked multiconsole games (on DSP port, accessible by optional add-on connector). Networking of up to 32 Jaguar units available.
- The two controller ports can be expanded to support "dozens" of controllers - Digital and analog interfaces - Keyboards, mice, and light guns are possible
- Expansion port allows connection to cable TV and other networks
- Digital Signal Processor port allows connection to modems and digital audio peripherals (such as DAT players)
- One megabyte per second serial interface
- 9600 baud, RS-232 serial port (accessible with optional interface)
- General-purpose I/O bits via the cartridge port
- Can accommodate future expansions of different processor types, I/O types, video types, and memory types and/or quantities.

Nintendo GameBoy Colour Specifications







Technical Specs

<u>Processor:</u>	Z80 Sharp processor
<u>Processor Speed:</u>	8 MHz
<u>RAM:</u>	32K
<u>Video RAM (VRAM):</u>	16K
<u>Colors Available:</u>	32,000
<u>Colors On Screen:</u>	10, 32, or 56
<u>Resolution:</u>	160x144 @56 colors and 320x288 @24colors
<u>Sound:</u>	4-channel FM sound
<u>Controls:</u>	8-directional D-Pad, A, B, select, and Start buttons
<u>Power:</u>	10+ hours on 2 AA batteries. AC adapter separately available





Appendix IV - Statistics

Polls taken from JoseQ's Emuviews @ <http://www.emuviews.com/>, on 27 July 2000







Question: What age group do you fall on?

1 to 12	 1.4%
13 to 17	 7.9%
18 to 23	 30.6%
24 to 29	 32.8%
30 or older	 27.3%
Total Votes: 1910	





Question: How much would you be willing to pay for your favorite ROMs?

Nothing.	 29.5%
From \$1 to \$5 dollars.	 37.8%
I would pay up to \$10 dollars.	 18.5%
\$20 dollars is my limit.	 7.5%
Just like any other computer game.	 6.7%
Total Votes: 1139	









Question: Why are you part of the scene?

I just like free games.	 2.9%
I like classic Arcade gaming.	 49.5%
I like more recent Arcade games.	 4.5%
I'm nostalgic about consoles (NES, SMS).	 14.4%
Newer consoles gaming (PSX, N64).	 0.6%
All of the above.	 28.1%
Total Votes: 1393	

Question: Which Platform do you prefer?

Windows Environment	 54.9%
Plain DOS	 20.0%
Unix (Any Flavor)	 8.3%
Mac	 13.9%
BeOS	 2.9%
Total Votes: 1248	

Question: Where in the world are you?

North America	 44.0%
Central America	 0.6%
South America	 5.1%
Caribbean	 0.2%
Europe	 41.5%
Asia	 3.8%
Africa	 0.4%
Australia	 4.4%
Total Votes: 1911	

Appendix V - The Software Directive

The Directive is exactly as presented in EuroLex, @ http://europa.eu.int/eur-lex/en/lif/dat/1991/en_391L0250.html, but note that Article 8 was struck out by Article 11 of Council Directive 93/98/EEC of 29 October 1993 harmonizing the term of protection of copyright and certain related rights, Official Journal NO. L 290, 24/11/1993 P. 0009 – 0013. Some aesthetic interventions were also made. Bear in mind however that Eurolex documents are not official documentations and some (minor) mistakes might be present, e.g. an orthographic mistake in Article 4(a). The purpose for including the Directive in the Appendix is the benefit of the reader.

*

391L0250

Council Directive 91/250/EEC of 14 May 1991 on the legal protection of computer programs

Official Journal L 122 , 17/05/1991 p. 0042 - 0046

Finnish special edition....: Chapter 17 Volume 1 p. 111

Swedish special edition....: Chapter 17 Volume 1 p. 111

Text:

COUNCIL DIRECTIVE of 14 May 1991 on the legal protection of computer programs (91/250/EEC)

THE COUNCIL OF THE EUROPEAN COMMUNITIES,

Having regard to the Treaty establishing the European Economic Community and in particular Article 100a thereof,

Having regard to the proposal from the Commission (1),

In cooperation with the European Parliament (2),

Having regard to the opinion of the Economic and Social Committee (3),

1. Whereas computer programs are at present not clearly protected in all Member States by existing legislation and such protection, where it exists, has different attributes;
2. Whereas the development of computer programs requires the investment of considerable human, technical and financial resources while computer programs can be copied at a fraction of the cost needed to develop them independently;
3. Whereas computer programs are playing an increasingly important role in a broad range of industries and computer program technology can accordingly be considered as being of fundamental importance for the Community's industrial development;
4. Whereas certain differences in the legal protection of computer programs offered by the laws of the Member States have direct and negative effects on the functioning of the common market as regards computer programs and such

differences could well become greater as Member States introduce new legislation on this subject;

5. Whereas existing differences having such effects need to be removed and new ones prevented from arising, while differences not adversely affecting the functioning of the common market to a substantial degree need not be removed or prevented from arising;
6. Whereas the Community's legal framework on the protection of computer programs can accordingly in the first instance be limited to establishing that Member States should accord protection to computer programs under copyright law as literary works and, further, to establishing who and what should be protected, the exclusive rights on which protected persons should be able to rely in order to authorize or prohibit certain acts and for how long the protection should apply;
7. Whereas, for the purpose of this Directive, the term 'computer program' shall include programs in any form, including those which are incorporated into hardware; whereas this term also includes preparatory design work leading to the development of a computer program provided that the nature of the preparatory work is such that a computer program can result from it at a later stage;
8. Whereas, in respect of the criteria to be applied in determining whether or not a computer program is an original work, no tests as to the qualitative or aesthetic merits of the program should be applied;
9. Whereas the Community is fully committed to the promotion of international standardization;
10. Whereas the function of a computer program is to communicate and work together with other components of a computer system and with users and, for this purpose, a logical and, where appropriate, physical interconnection and interaction is required to permit all elements of software and hardware to work with other software and hardware and with users in all the ways in which they are intended to function;
11. Whereas the parts of the program which provide for such interconnection and interaction between elements of software and hardware are generally known as 'interfaces';
12. Whereas this functional interconnection and interaction is generally known as 'interoperability'; whereas such interoperability can be defined as the ability to exchange information and mutually to use the information which has been exchanged;
13. Whereas, for the avoidance of doubt, it has to be made clear that only the expression of a computer program is protected and that ideas and principles which underlie any element of a program, including those which underlie its interfaces, are not protected by copyright under this Directive;
14. Whereas, in accordance with this principle of copyright, to the extent that logic, algorithms and programming languages comprise ideas and principles, those ideas and principles are not protected under this Directive;
15. Whereas, in accordance with the legislation and jurisprudence of the Member States and the international copyright conventions, the expression of those ideas and principles is to be protected by copyright;
16. Whereas, for the purposes of this Directive, the term 'rental' means the making available for use, for a limited period of time and for profit-making purposes, of a computer program or a copy thereof; whereas this term does not include

public lending, which, accordingly, remains outside the scope of this Directive;

17. Whereas the exclusive rights of the author to prevent the unauthorized reproduction of his work have to be subject to a limited exception in the case of a computer program to allow the reproduction technically necessary for the use of that program by the lawful acquirer;
18. Whereas this means that the acts of loading and running necessary for the use of a copy of a program which has been lawfully acquired, and the act of correction of its errors, may not be prohibited by contract; whereas, in the absence of specific contractual provisions, including when a copy of the program has been sold, any other act necessary for the use of the copy of a program may be performed in accordance with its intended purpose by a lawful acquirer of that copy;
19. Whereas a person having a right to use a computer program should not be prevented from performing acts necessary to observe, study or test the functioning of the program, provided that these acts do not infringe the copyright in the program;
20. Whereas the unauthorized reproduction, translation, adaptation or transformation of the form of the code in which a copy of a computer program has been made available constitutes an infringement of the exclusive rights of the author;
21. Whereas, nevertheless, circumstances may exist when such a reproduction of the code and translation of its form within the meaning of Article 4 (a) and (b) are indispensable to obtain the necessary information to achieve the interoperability of an independently created program with other programs;
22. Whereas it has therefore to be considered that in these limited circumstances only, performance of the acts of reproduction and translation by or on behalf of a person having a right to use a copy of the program is legitimate and compatible with fair practice and must therefore be deemed not to require the authorization of the rightholder;
23. Whereas an objective of this exception is to make it possible to connect all components of a computer system, including those of different manufacturers, so that they can work together;
24. Whereas such an exception to the author's exclusive rights may not be used in a way which prejudices the legitimate interests of the rightholder or which conflicts with a normal exploitation of the program;
25. Whereas, in order to remain in accordance with the provisions of the Berne Convention for the Protection of Literary and Artistic Works, the term of protection should be the life of the author and fifty years from the first of January of the year following the year of his death or, in the case of an anonymous or pseudonymous work, 50 years from the first of January of the year following the year in which the work is first published;
26. Whereas protection of computer programs under copyright laws should be without prejudice to the application, in appropriate cases, of other forms of protection; whereas, however, any contractual provisions contrary to Article 6 or to the exceptions provided for in Article 5 (2) and (3) should be null and void;
27. Whereas the provisions of this Directive are without prejudice to the application of the competition rules under Articles 85 and 86 of the Treaty if a

- dominant supplier refuses to make information available which is necessary for interoperability as defined in this Directive;
28. Whereas the provisions of this Directive should be without prejudice to specific requirements of Community law already enacted in respect of the publication of interfaces in the telecommunications sector or Council Decisions relating to standardization in the field of information technology and telecommunication;
 29. Whereas this Directive does not affect derogations provided for under national legislation in accordance with the Berne Convention on points not covered by this Directive,
- HAS ADOPTED THIS DIRECTIVE:

Article 1 Object of Protection

1. In accordance with the provisions of this Directive, Member States shall protect computer programs, by copyright, as literary works within the meaning of the Berne Convention for the Protection of Literary and Artistic Works. For the purposes of this Directive, the term 'computer programs' shall include their preparatory design material.
2. Protection in accordance with this Directive shall apply to the expression in any form of a computer program. Ideas and principles which underlie any element of a computer program, including those which underlie its interfaces, are not protected by copyright under this Directive.
3. A computer program shall be protected if it is original in the sense that it is the author's own intellectual creation. No other criteria shall be applied to determine its eligibility for protection.

Article 2 Authorship of Computer Programs

1. The author of a computer program shall be the natural person or group of natural persons who has created the program or, where the legislation of the Member State permits, the legal person designated as the rightholder by that legislation. Where collective works are recognized by the legislation of a Member State, the person considered by the legislation of the Member State to have created the work shall be deemed to be its author.
2. In respect of a computer program created by a group of natural persons jointly, the exclusive rights shall be owned jointly.
3. Where a computer program is created by an employee in the execution of his duties or following the instructions given by his employer, the employer exclusively shall be entitled to exercise all economic rights in the program so created, unless otherwise provided by contract.

Article 3 Beneficiaries of Protection

Protection shall be granted to all natural or legal persons eligible under national copyright legislation as applied to literary works.

Article 4 Restricted Acts

Subject to the provisions of Articles 5 and 6, the exclusive rights of the rightholder within the meaning of Article 2, shall include the right to do or to authorize:

- (a) the permanent or temporary reproduction of a computer program by any means and in any form, in part or in whole. Insofar as loading, displaying, running, transmission or storage of the computer program necessitate such reproduction, such acts shall be subject to authorization by the rightholder;
- (b) the translation, adaptation, arrangement and any other alteration of a computer program and the reproduction of the results thereof, without prejudice to the rights of the person who alters the program;
- (c) any form of distribution to the public, including the rental, of the original computer program or of copies thereof. The first sale in the Community of a copy of a program by the rightholder or with his consent shall exhaust the distribution right within the Community of that copy, with the exception of the right to control further rental of the program or a copy thereof.

Article 5 Exceptions to the Restricted Acts

1. In the absence of specific contractual provisions, the acts referred to in Article 4 (a) and (b) shall not require authorization by the rightholder where they are necessary for the use of the computer program by the lawful acquirer in accordance with its intended purpose, including for error correction.
2. The making of a back-up copy by a person having a right to use the computer program may not be prevented by contract insofar as it is necessary for that use.
3. The person having a right to use a copy of a computer program shall be entitled, without the authorization of the rightholder, to observe, study or test the functioning of the program in order to determine the ideas and principles which underlie any element of the program if he does so while performing any of the acts of loading, displaying, running, transmitting or storing the program which he is entitled to do.

Article 6 Decompilation

1. The authorization of the rightholder shall not be required where reproduction of the code and translation of its form within the meaning of Article 4 (a) and (b) are indispensable to obtain the information necessary to achieve the interoperability of an independently created computer program with other programs, provided that the following conditions are met:
 - (a) these acts are performed by the licensee or by another person having a right to use a copy of a program, or on their behalf by a person authorized to do so;
 - (b) the information necessary to achieve interoperability has not previously been readily available to the persons referred to in subparagraph (a); and
 - (c) these acts are confined to the parts of the original program which are necessary to achieve interoperability.
2. The provisions of paragraph 1 shall not permit the information obtained through its application:
 - (a) to be used for goals other than to achieve the interoperability of the independently created computer program;

(b) to be given to others, except when necessary for the interoperability of the independently created computer program; or
(c) to be used for the development, production or marketing of a computer program substantially similar in its expression, or for any other act which infringes copyright.

3. In accordance with the provisions of the Berne Convention for the protection of Literary and Artistic Works, the provisions of this Article may not be interpreted in such a way as to allow its application to be used in a manner which unreasonably prejudices the right holder's legitimate interests or conflicts with a normal exploitation of the computer program.

Article 7 Special Measures of Protection

1. Without prejudice to the provisions of Articles 4, 5 and 6, Member States shall provide, in accordance with their national legislation, appropriate remedies against a person committing any of the acts listed in subparagraphs (a), (b) and (c) below:

(a) any act of putting into circulation a copy of a computer program knowing, or having reason to believe, that it is an infringing copy;

(b) the possession, for commercial purposes, of a copy of a computer program knowing, or having reason to believe, that it is an infringing copy;

(c) any act of putting into circulation, or the possession for commercial purposes of, any means the sole intended purpose of which is to facilitate the unauthorized removal or circumvention of any technical device which may have been applied to protect a computer program.

2. Any infringing copy of a computer program shall be liable to seizure in accordance with the legislation of the Member State concerned.

3. Member States may provide for the seizure of any means referred to in paragraph 1 (c).

Article 8 Term of Protection

1. Protection shall be granted for the life of the author and for fifty years after his death or after the death of the last surviving author; where the computer program is an anonymous or pseudonymous work, or where a legal person is designated as the author by national legislation in accordance with Article 2 (1), the term of protection shall be fifty years from the time that the computer program is first lawfully made available to the public. The term of protection shall be deemed to begin on the first of January of the year following the abovementioned events.

2. Member States which already have a term of protection longer than that provided for in paragraph 1 are allowed to maintain their present term until such time as the term of protection for copyright works is harmonized by Community law in a more general way.

Article 9 Continued Application of other Legal Provisions

1. The provisions of this Directive shall be without prejudice to any other legal provisions such as those concerning patent rights, trade-marks, unfair competition, trade secrets, protection of semi-conductor products or the law of contract. Any

contractual provisions contrary to Article 6 or to the exceptions provided for in Article 5 (2) and (3) shall be null and void.

2. The provisions of this Directive shall apply also to programs created before 1 January 1993 without prejudice to any acts concluded and rights acquired before that date.

Article 10 Final Provisions

1. Member States shall bring into force the laws, regulations and administrative provisions necessary to comply with this Directive before 1 January 1993. When Member States adopt these measures, the latter shall contain a reference to this Directive or shall be accompanied by such reference on the occasion of their official publication. The methods of making such a reference shall be laid down by the Member States.

2. Member States shall communicate to the Commission the provisions of national law which they adopt in the field governed by this Directive.

Article 11

This Directive is addressed to the Member States. Done at Brussels, 14 May 1991.

All copyright materials and trademarks are property of their respective owners and are used for the sake of reference. All materials taken from websites have been reproduced upon permission, where needed, from their respective webmasters.
All Rights Reserved © Takis Tsiricos 2000